



**TWO AND THREE LAYER
MASTER CURVES
FOR SCHLUMBERGER SOUNDING
INTERPRETATION**

From ORELLANA and MOONEY

IRIS Instruments

1, avenue Buffon, BP 6007, 45060 Orléans cédex 02, France

Tel : + 332 38 63 81 00 Fax : + 332 38 63 81 82

E-mail : info@iris-instruments.com Web site: iris-instruments.com

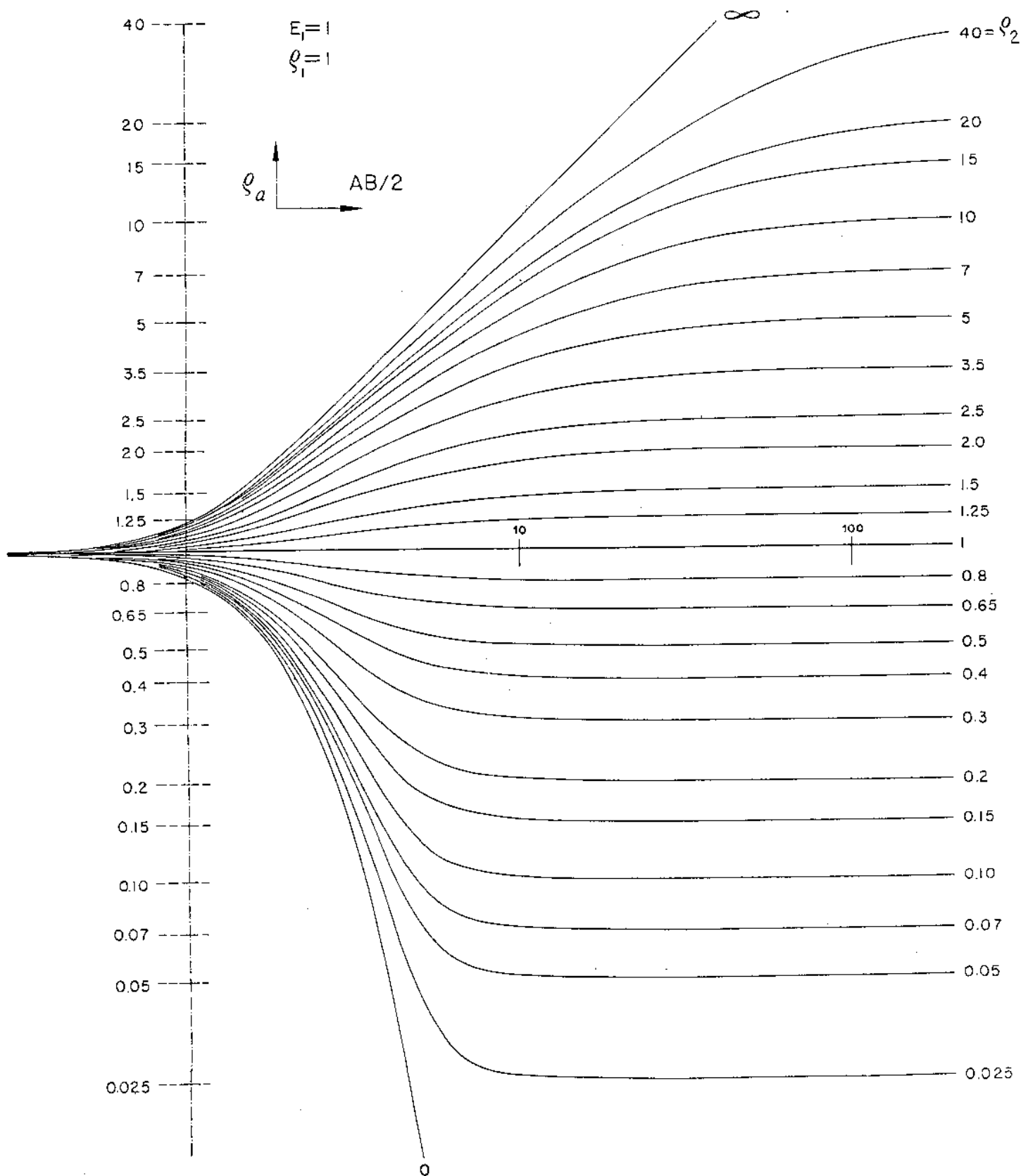

ORELLANA—MOONEY
 MASTER CURVES FOR V.E.S.
 CURVAS PATRON PARA S.E.V.

TWO — LAYER CURVES — CURVAS DE DOS CAPAS

HOW TO USE THE THREE LAYER MASTER CURVES

The three layer master curves are classified in four parts according to their shapes :

1 - The bowl type (diagrams H-1 to H-25)



2 - The bell type (diagrams K-1 to K-25)



3 - The stair step down (diagrams Q-1 to Q-13)

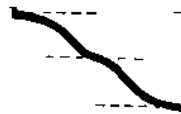

4 - The stair step up (diagrams A-1 to A-13)

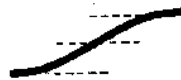

The parameters of the three layer solution are :

- ρ_1 : resistivity of the first layer
- ρ_2 : resistivity of the second layer
- ρ_3 : resistivity of the third layer
- E1 : thickness of the first layer
- E2 : thickness of the second layer
- E1 + E2 : depth of the third layer

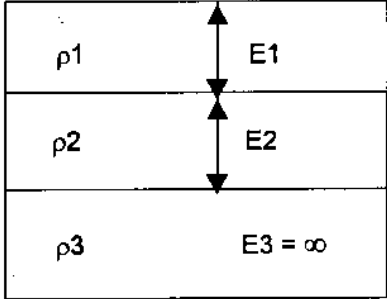

The field curve, plotted on a transparent paper has to be superposed on a curve of the diagram which fits it. Then, the values of the parameters ρ_1 , ρ_2 , ρ_3 , and E1 can be read directly on the transparent paper according to the graphical indications mentioned in the example here under presented. The parameter E2 is obtained by multiplying the coefficient shown in the small square by the value of E1.

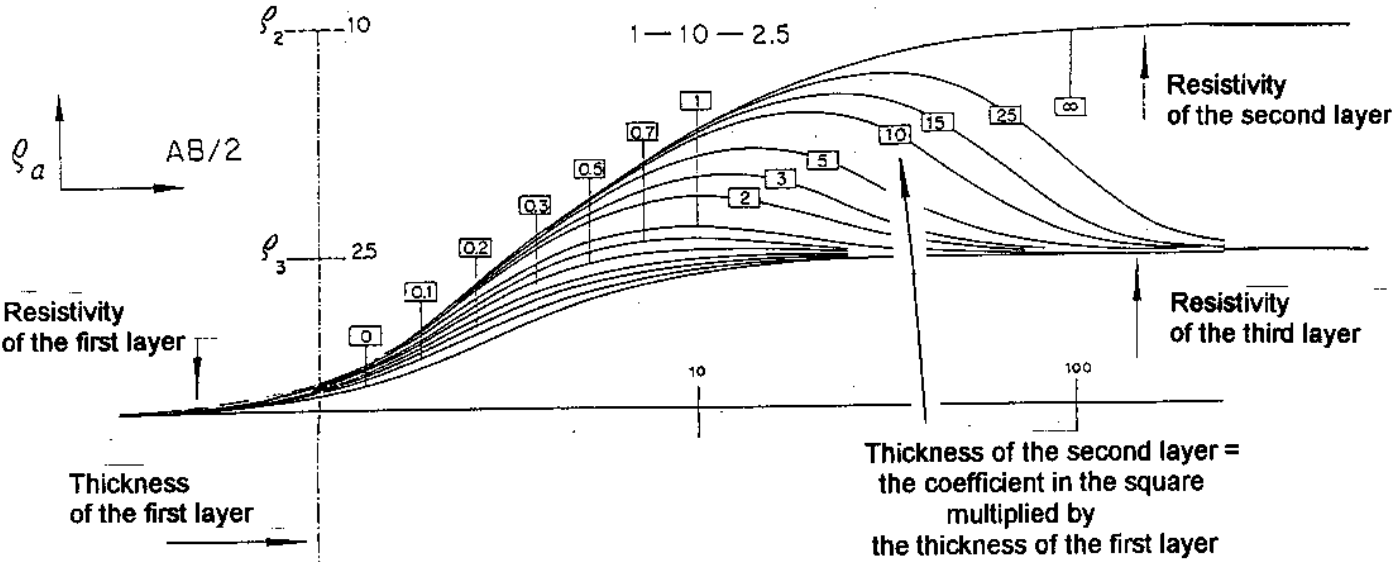

H-1

1 - 0.65 - 0.8

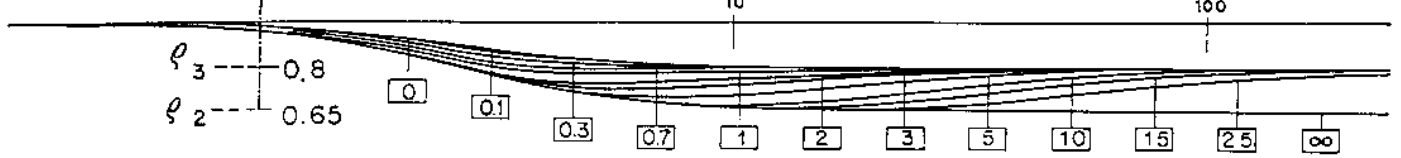

H-2

1 - 0.65 - 1



H-3

1 - 0.65 - 5

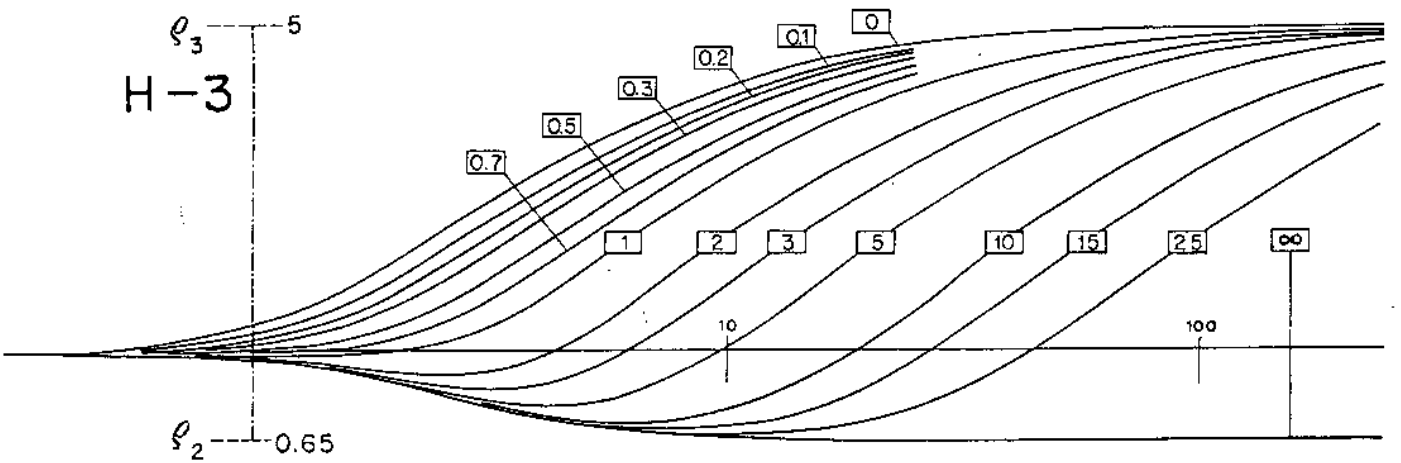

H-4

1 - 0.65 - infinity

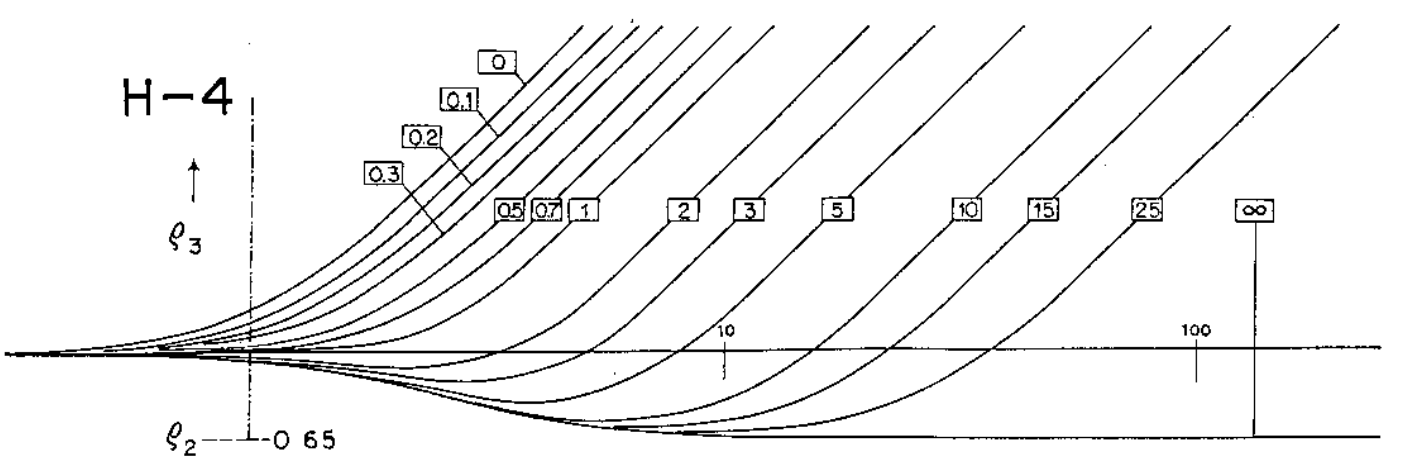

$$E_1 = 1; \rho_1 = 1; E_2 = \square$$

ORELLANA - MOONEY
 MASTER CURVES FOR VES.
 CURVAS PATRON PARA S.E.V.

THREE - LAYER CURVES - CURVAS DE TRES CAPAS

H-5

1-0.4-0.65

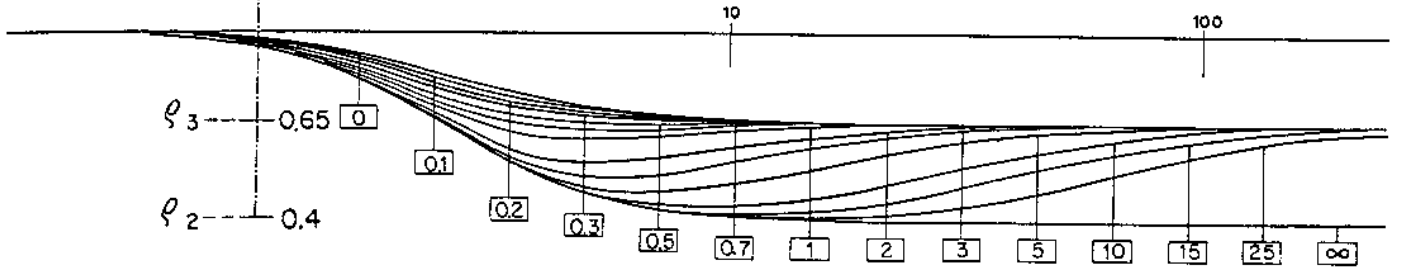

H-6

1-0.4-1

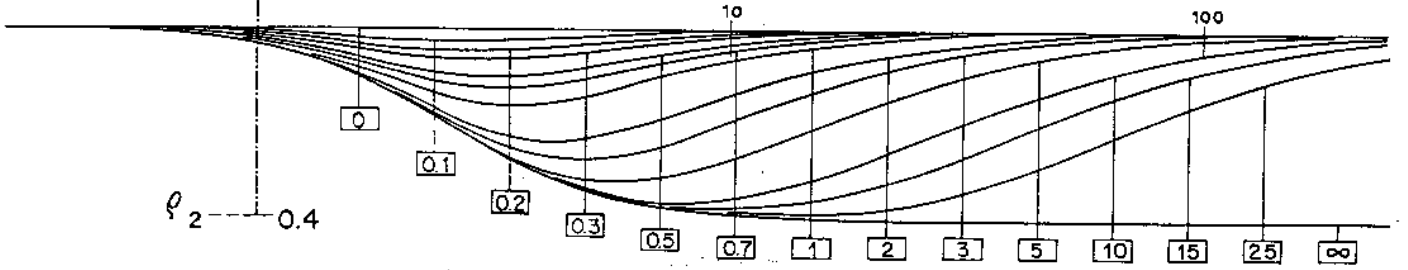

ρ_a ↑
 → AB/2

1-0.4-2.5

H-7

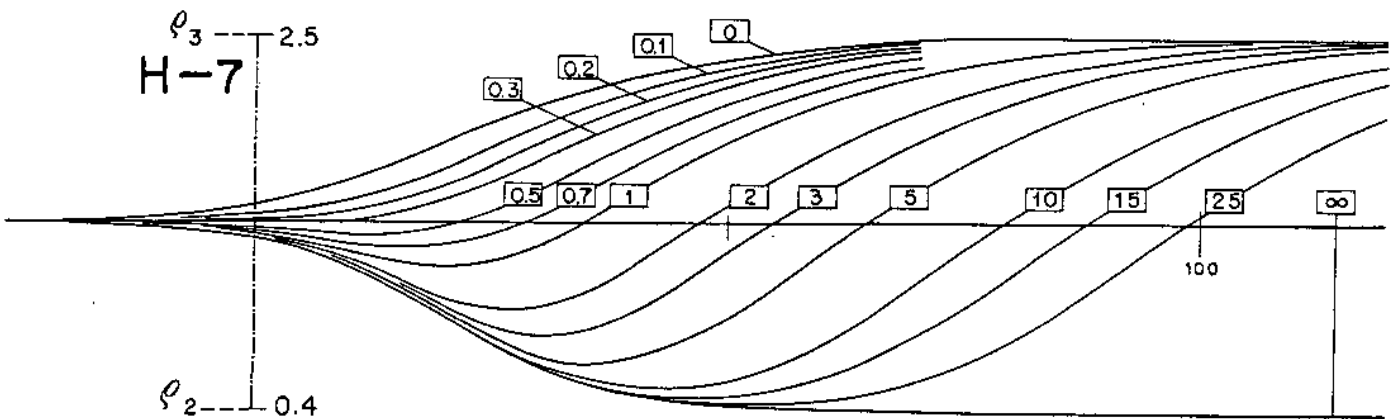

$$E_1 = 1; \rho_1 = 1; E_2 = \square$$

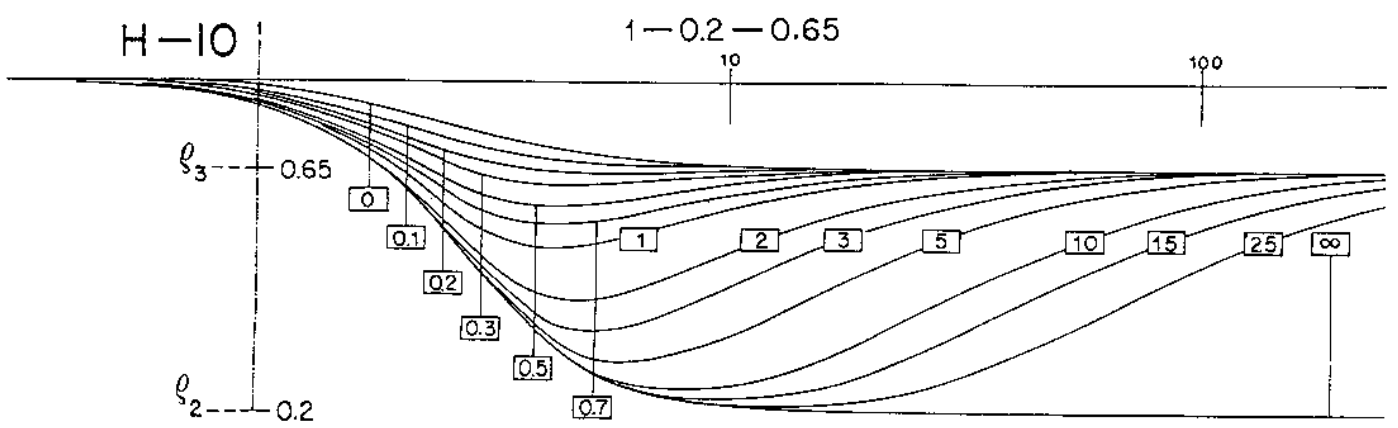
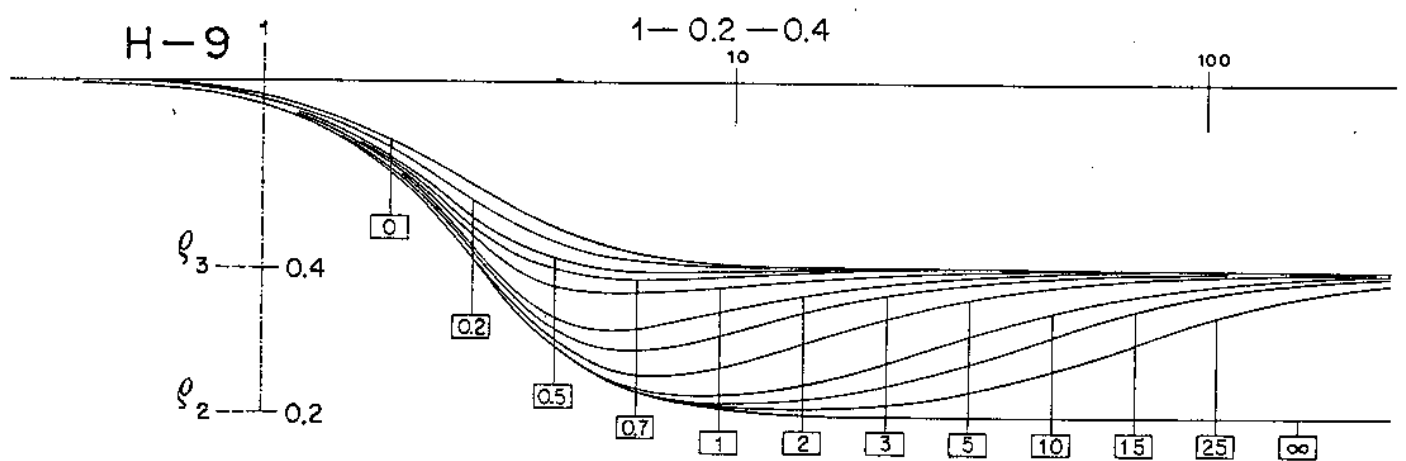
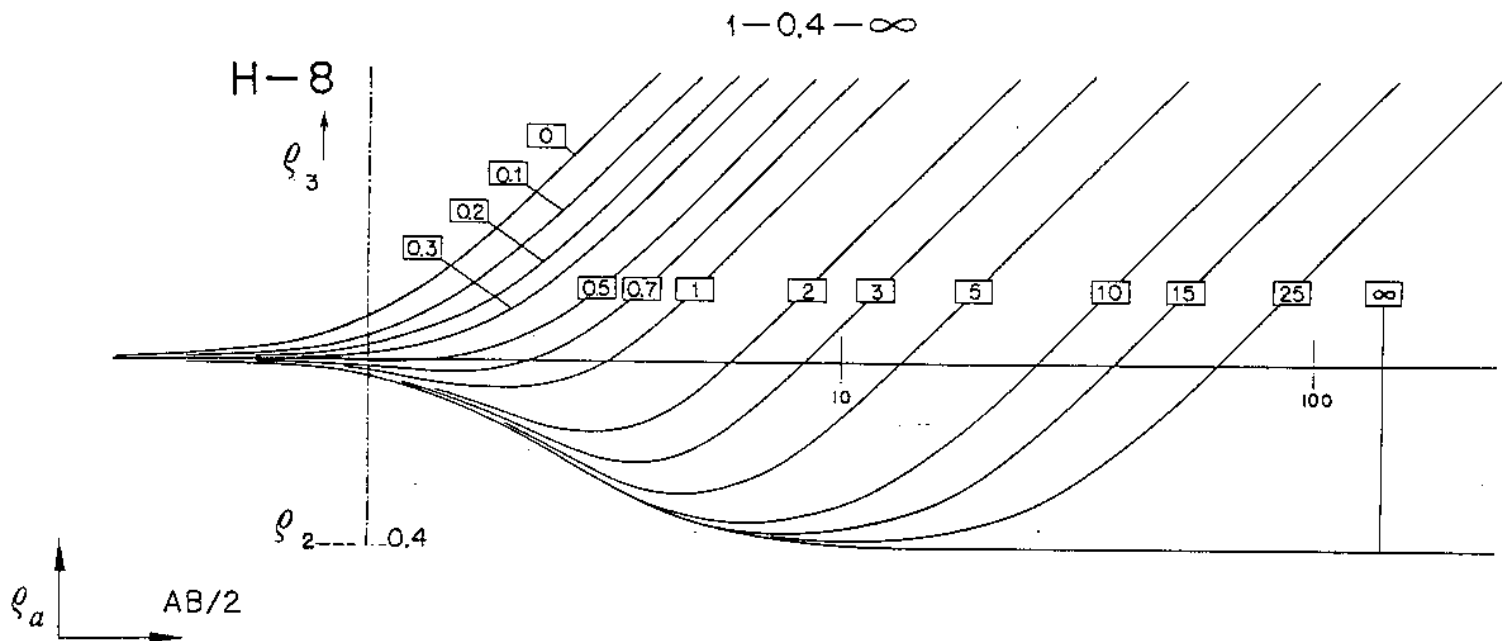

$E_1 = 1; \rho_1 = 1; E_2 = \square$

ORELLANA—MOONEY
 MASTER CURVES FOR VES
 CURVAS PATRON PARA SEV.

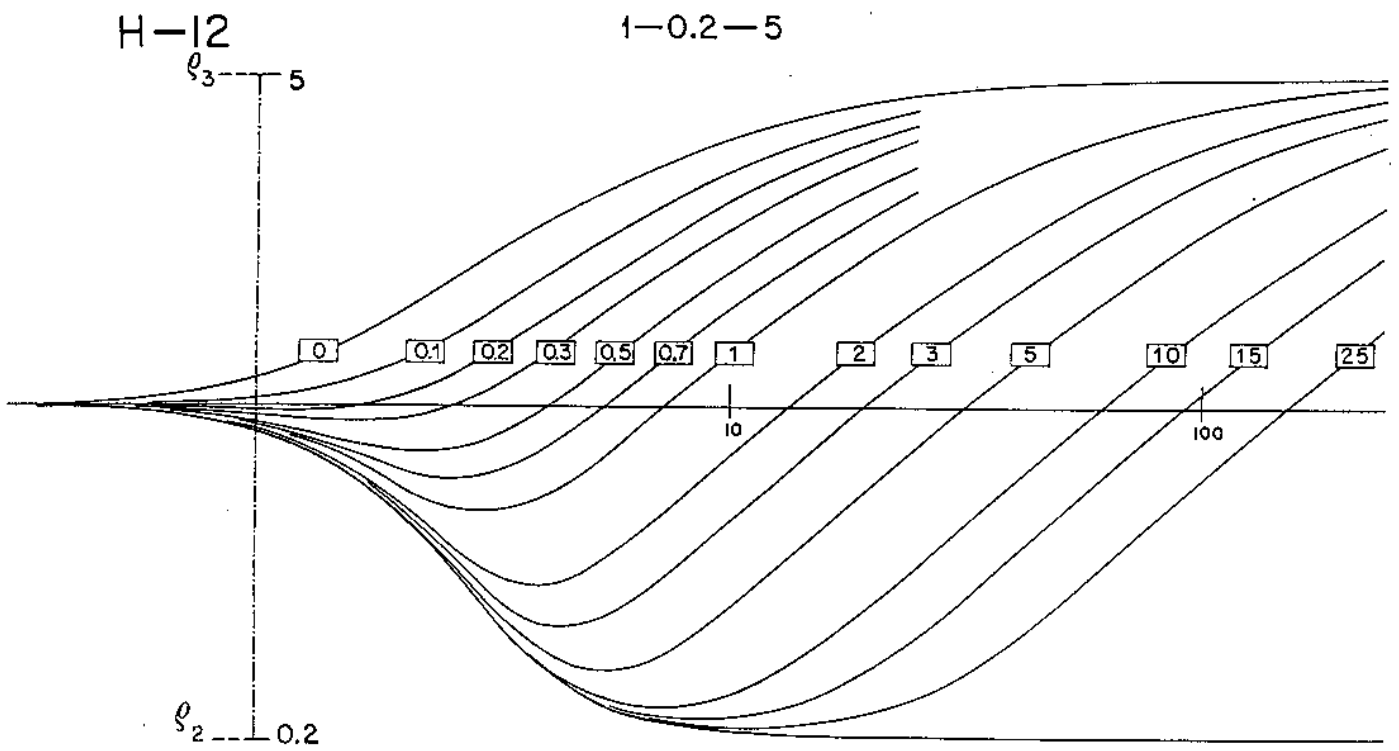
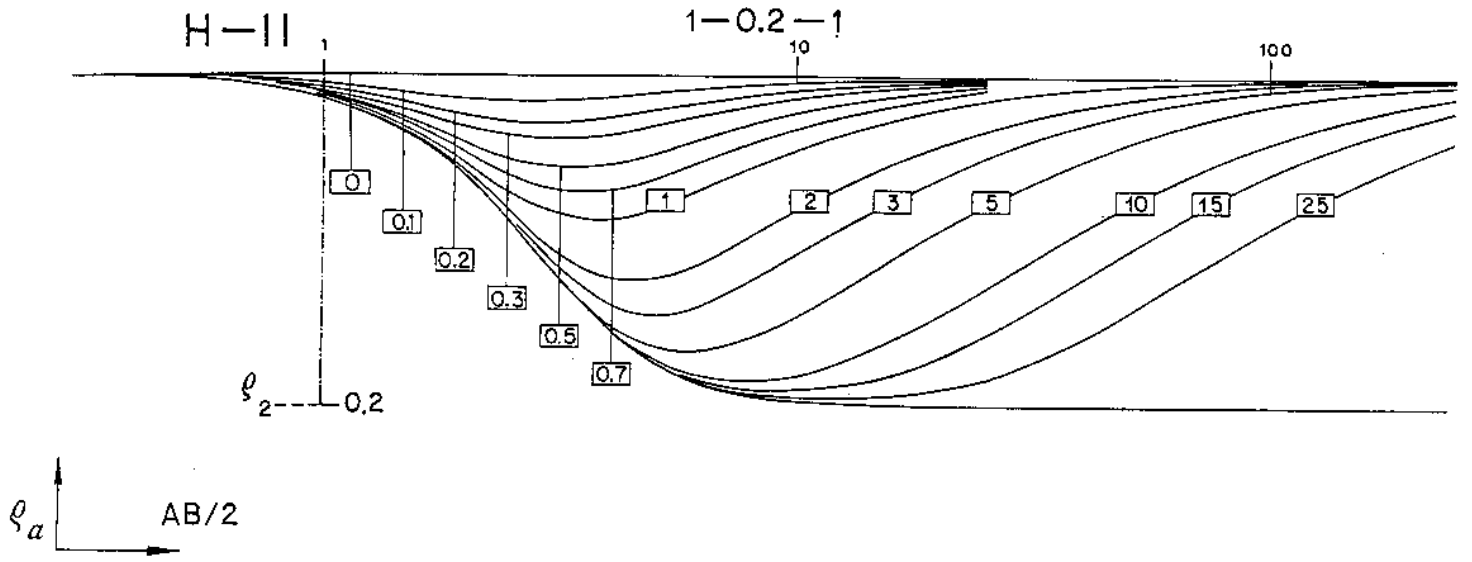

$$E_1 = 1; \rho_1 = 1; E_2 = \square$$

ORELLANA — MOONEY
 MASTER CURVES FOR V.E.S.
 CURVAS PATRON PARA S.E.V.

H-13

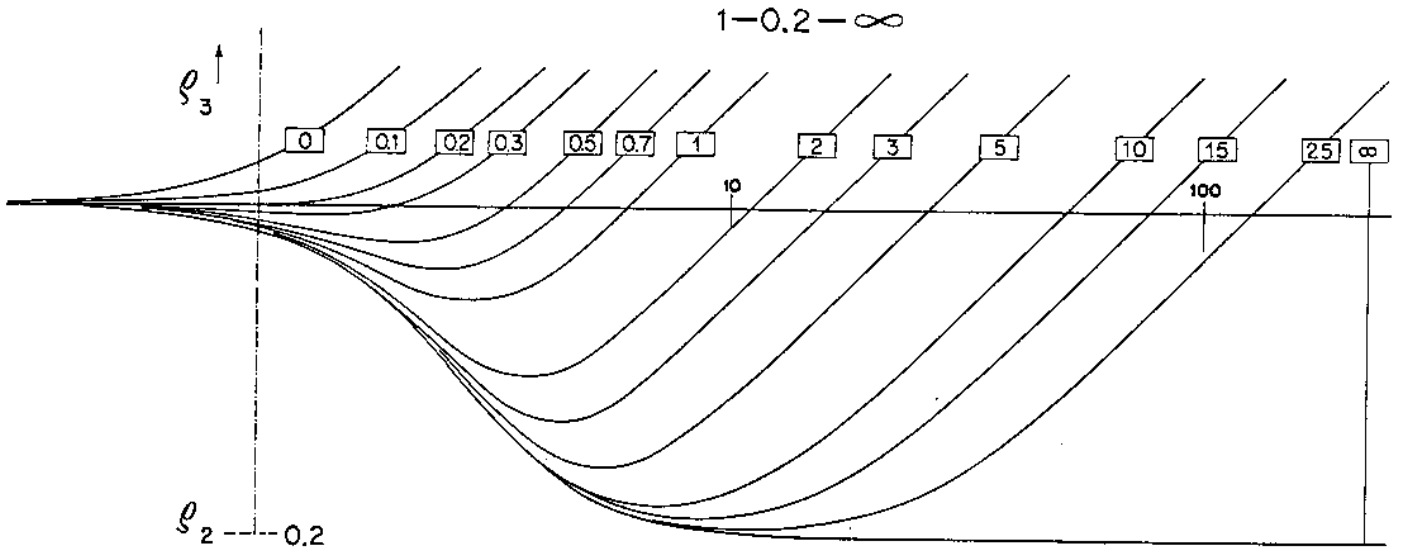

ν_a ↑
AB/2 →

H-14

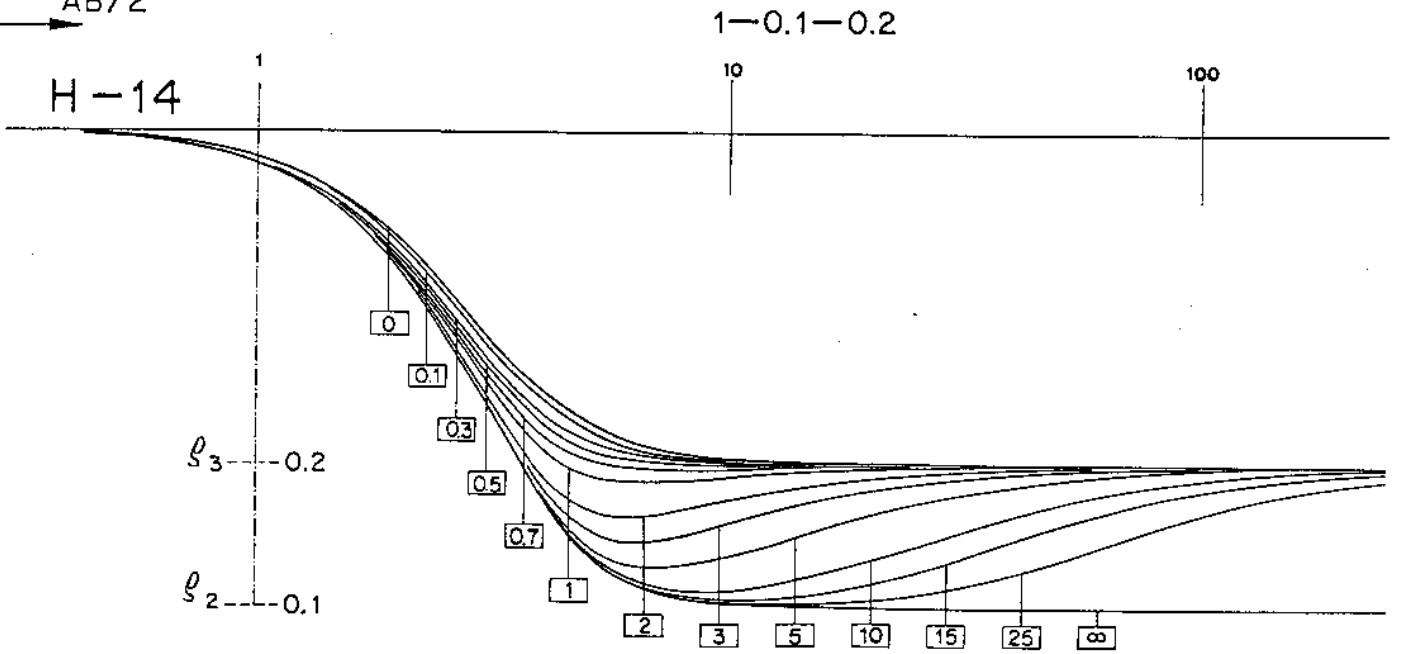

$$E_1 = 1; \nu_1 = 1; E_2 = \square$$

H-15

1-0.1-0.4

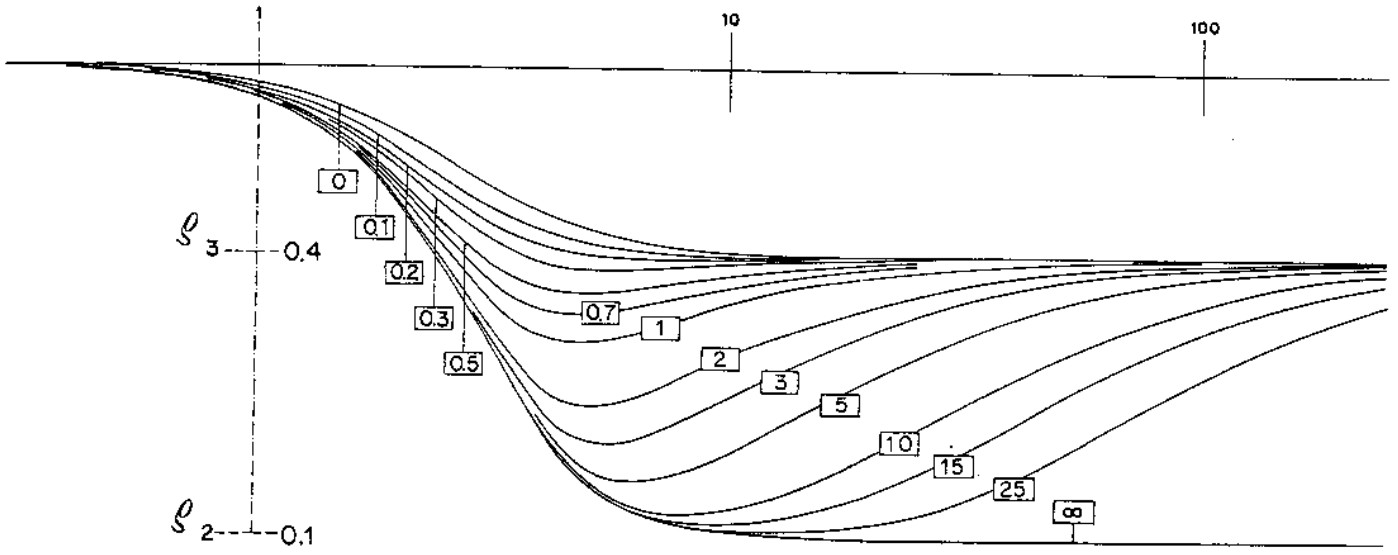

ν_a \rightarrow $AB/2$

H-16

1-0.1-1

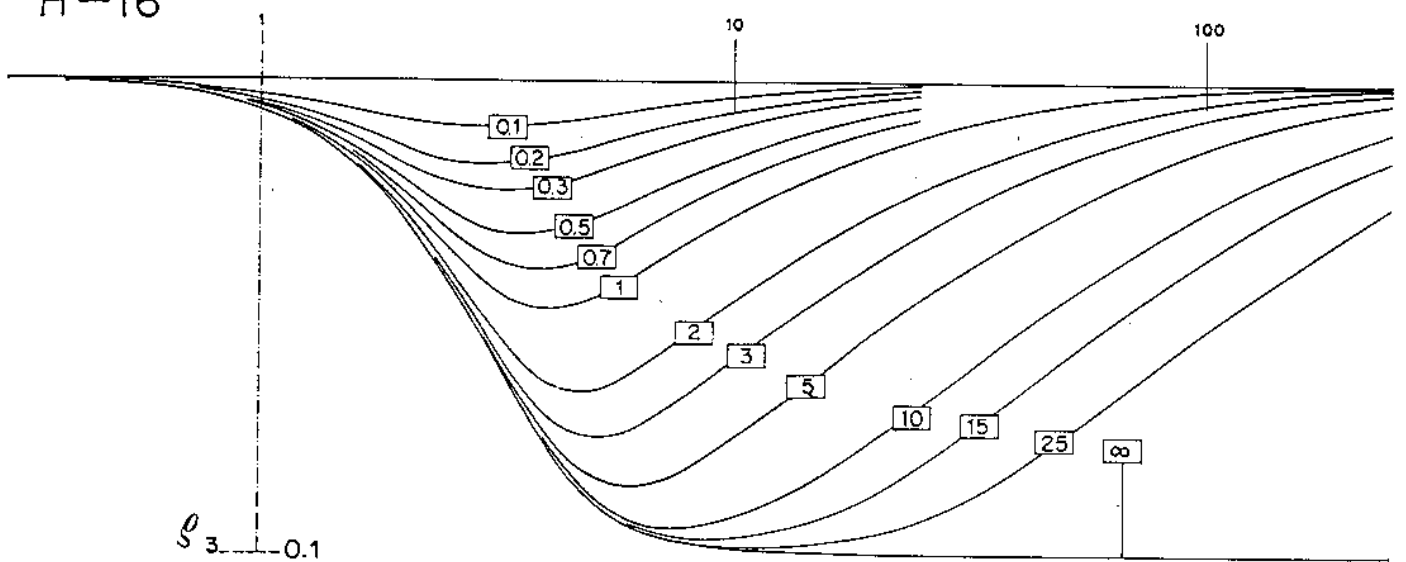

$$E_1 = 1; \nu = 1; E_2 = \square$$

H-17

1-0.1-∞

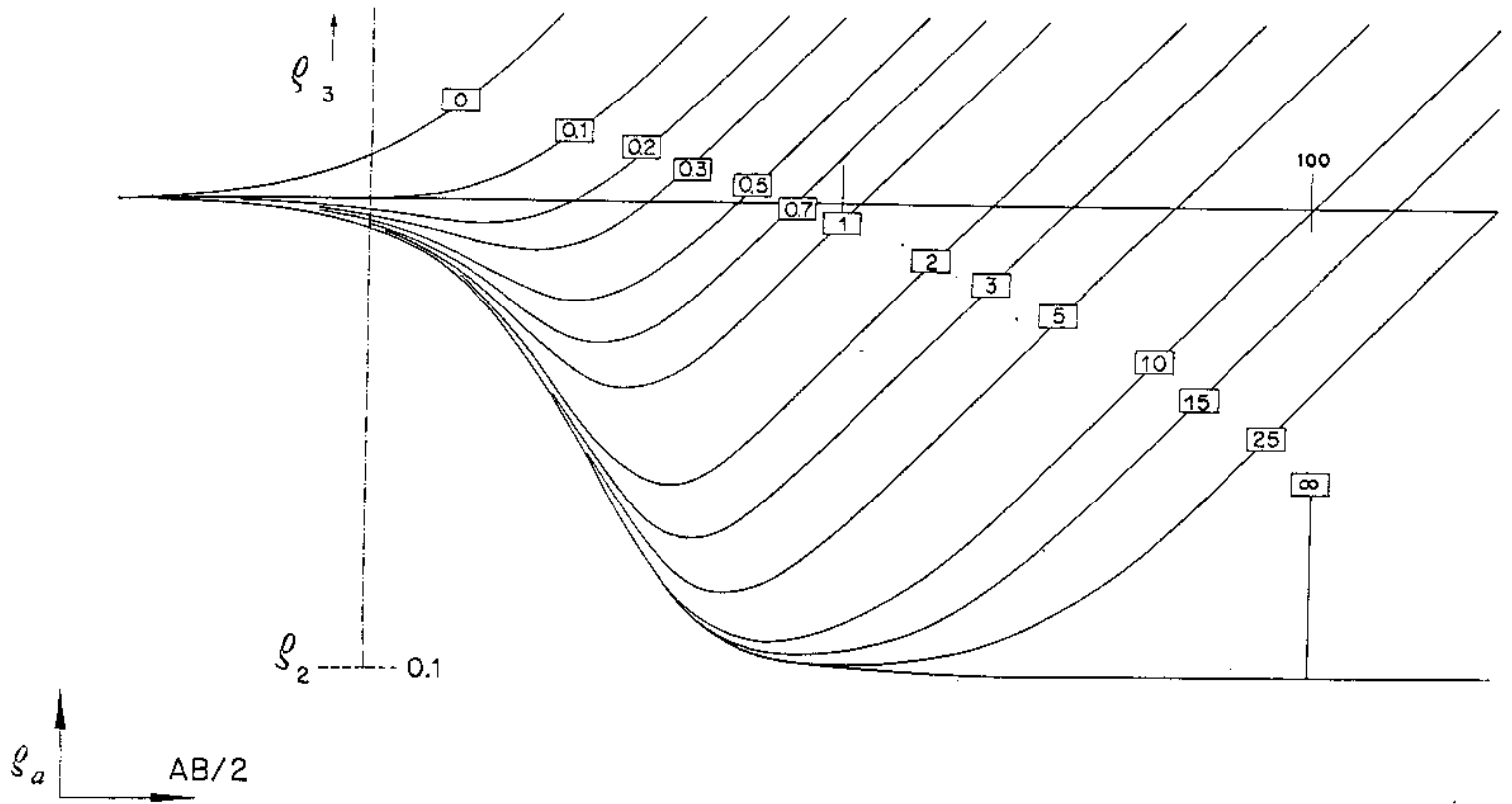

H-18

1-0.05-0.1

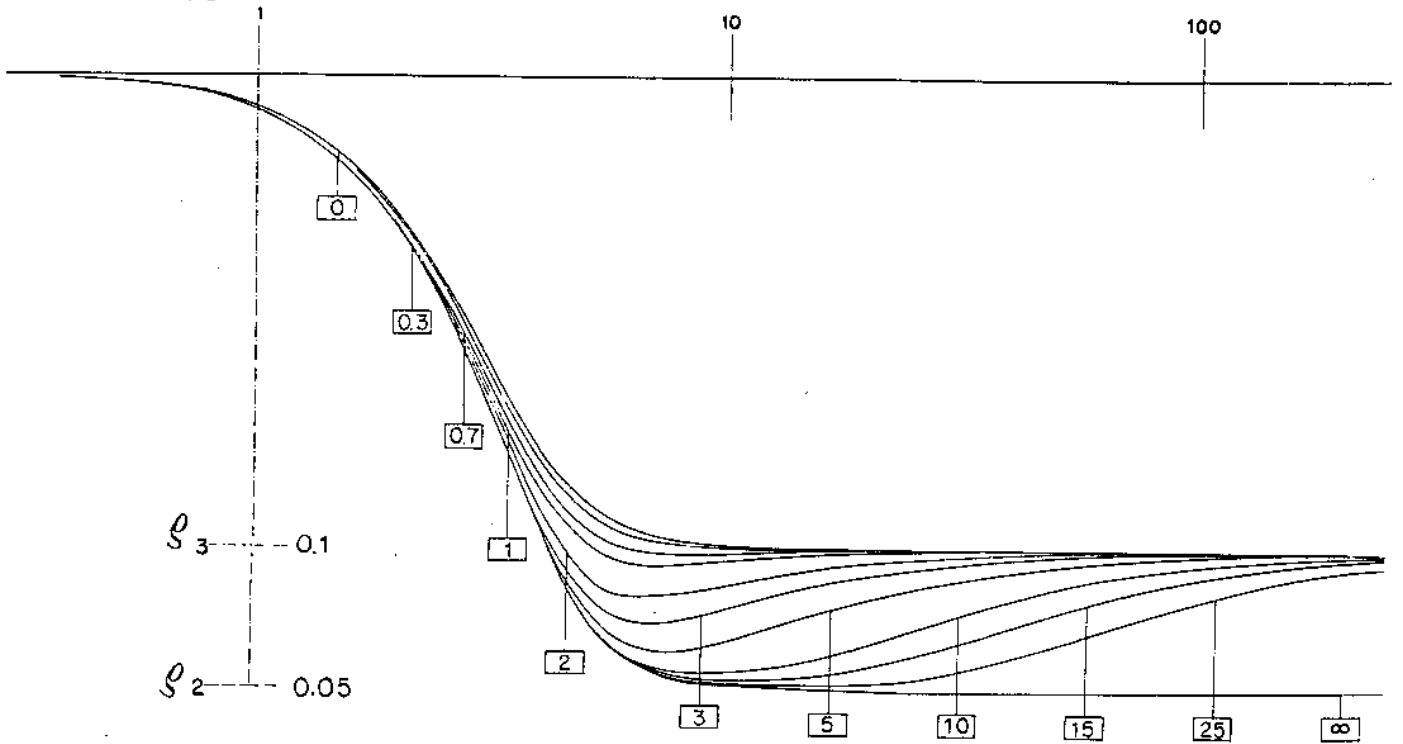

ORELLANA - MOONEY
MASTER CURVES FOR VES
CURVAS PATRON PARA S.E.V.

$$E_1 = 1; \rho_1 = 1; E_2 = \square$$

H-19

1-0.05-0.2

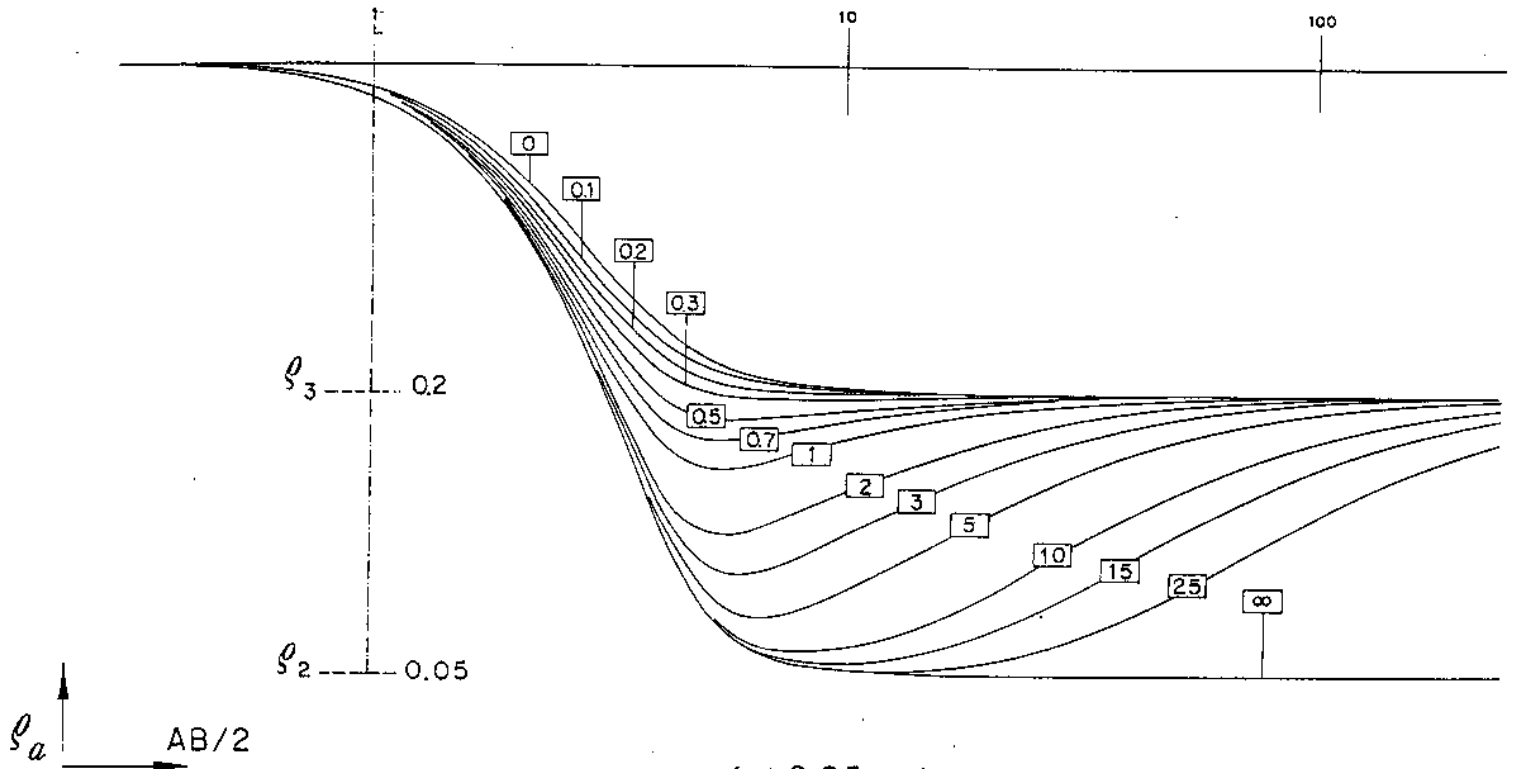

H-20

1-0.05-1

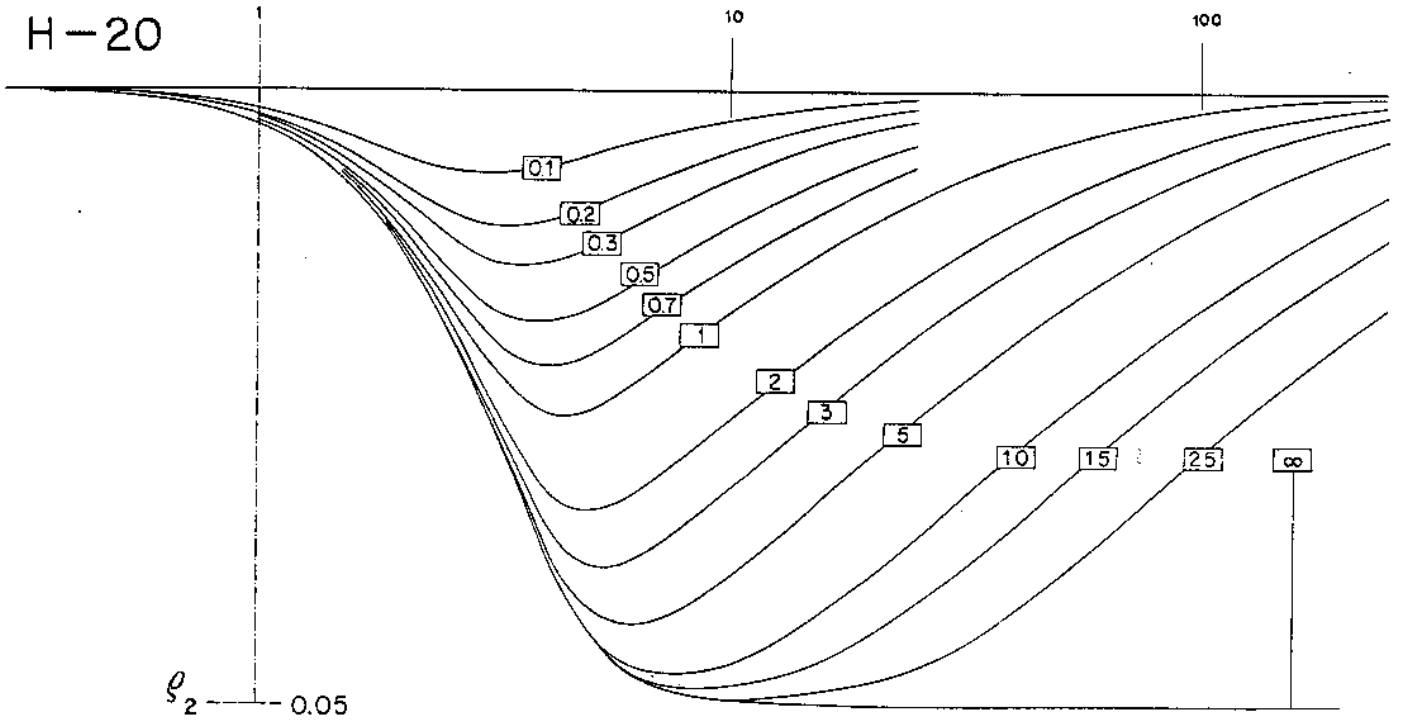

$$E_1 = 1; \rho_1 = 1; E_2 = \square$$

H-21

1 - 0.05 - ∞

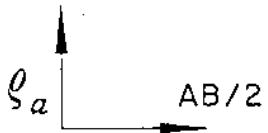
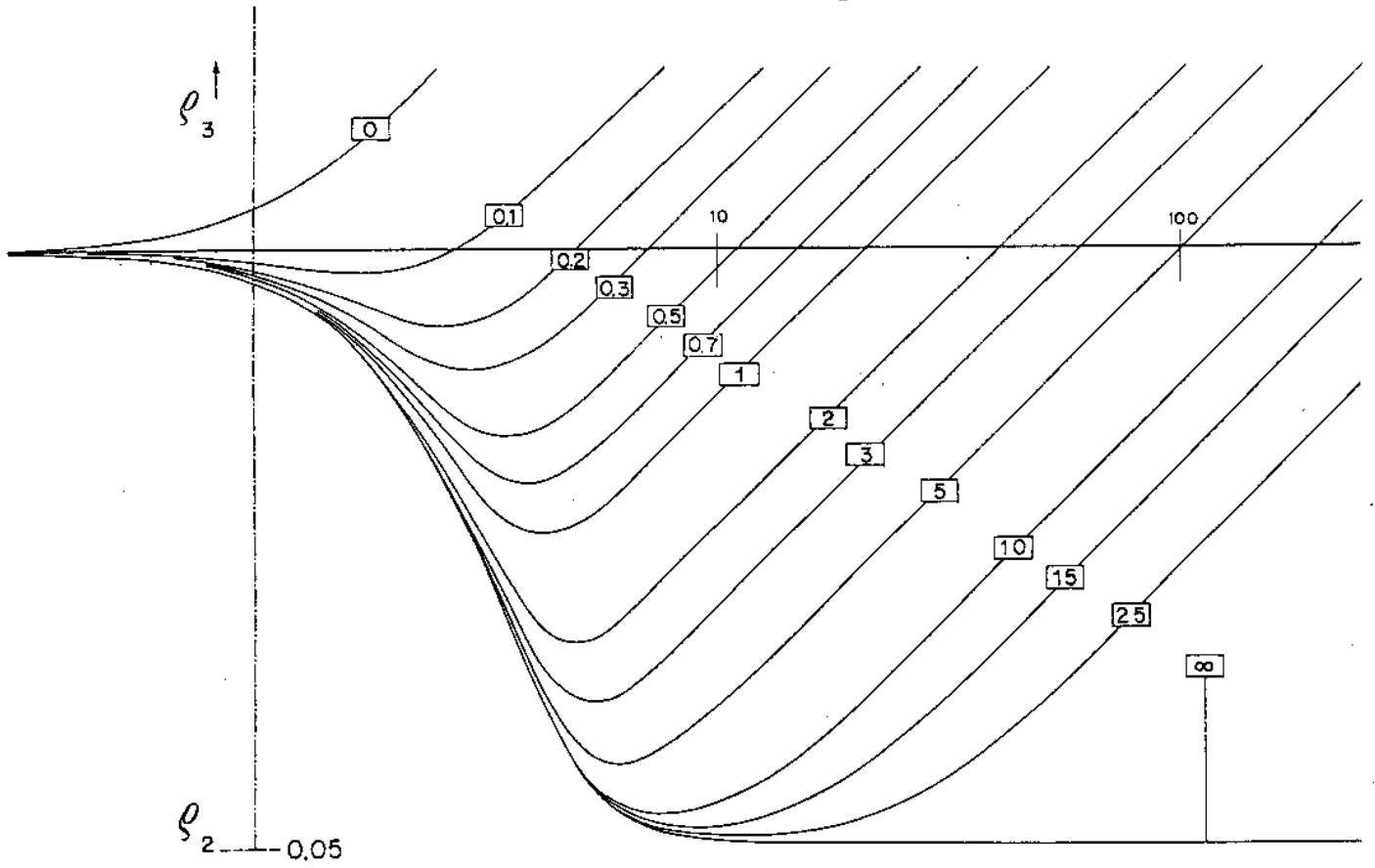

$$E_1 = 1; \rho_1 = 1; E_2 = \square$$

ORELLANA — MOONEY
MASTER CURVES FOR VES.
CURVAS PATRON PARA SEV.

H-22

1-0.025-0.05

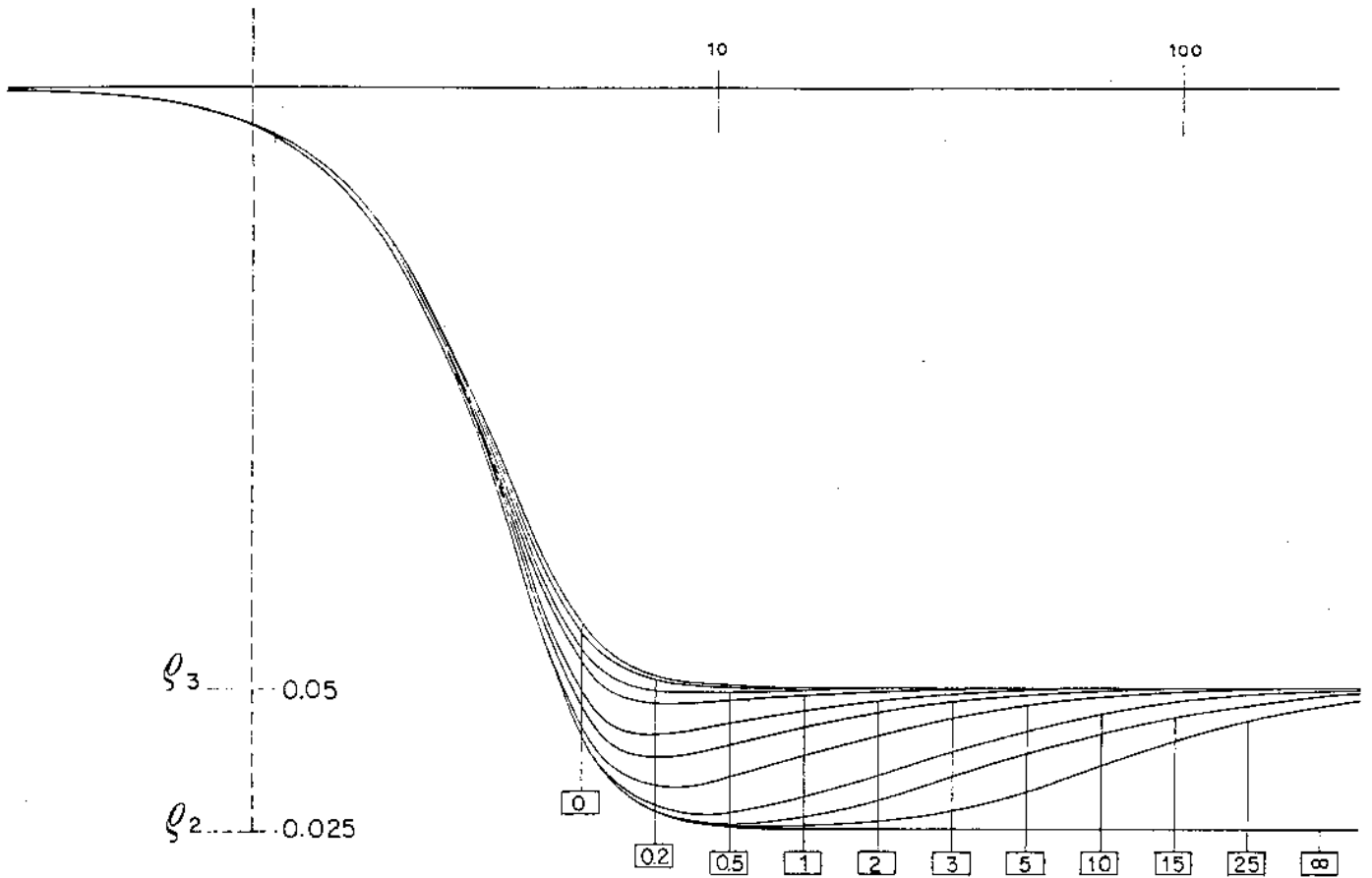

$$E_1 = 1; \rho_1 = 1; E_2 = \square$$

ORELLANA—MOONEY
MASTER CURVES FOR V.E.S.
CURVAS PATRON PARA S.E.V.

H-23

1-0.025-0.1

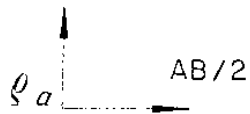
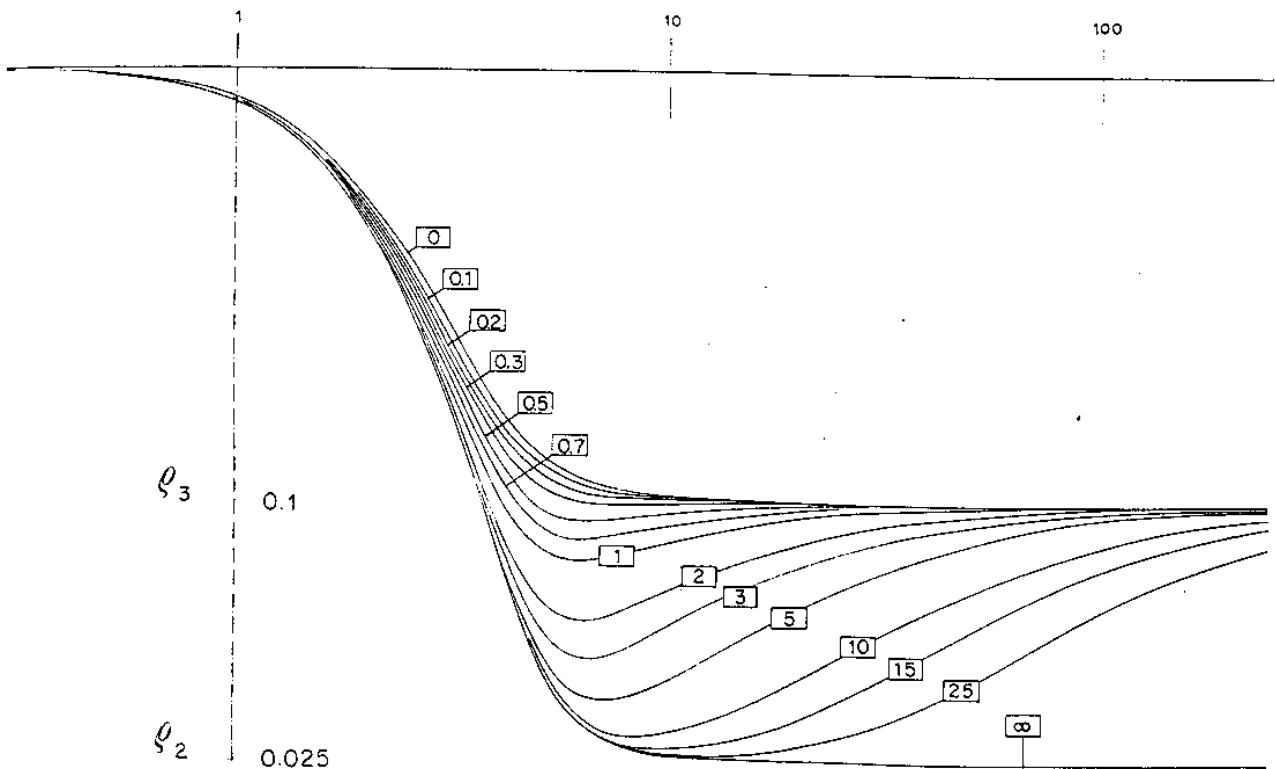

$$E_1 = 1; \rho_1 = 1; E_2 = \square$$

ORELLANA—MOONEY
MASTER CURVES FOR VES.
CURVAS PATRON PARA S.E.V.

H-24

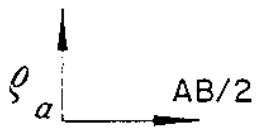
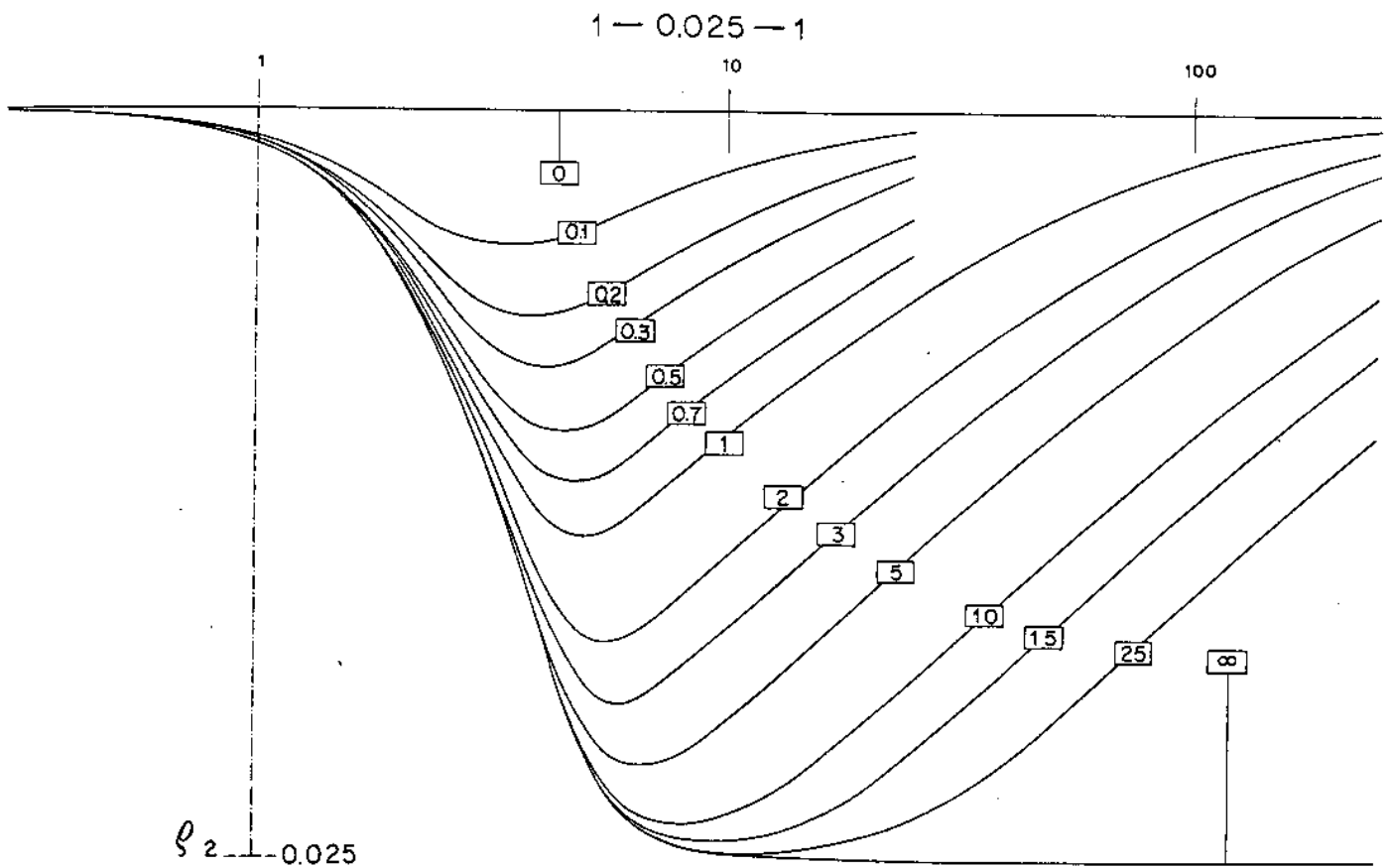

$$E_1 = 1; \rho_1 = 1; E_2 = \square$$

ORELLANA - MOONEY
MASTER CURVES FOR VES.
CURVAS PATRON PARA SEV.

H - 25

1 - 0.025 - ∞

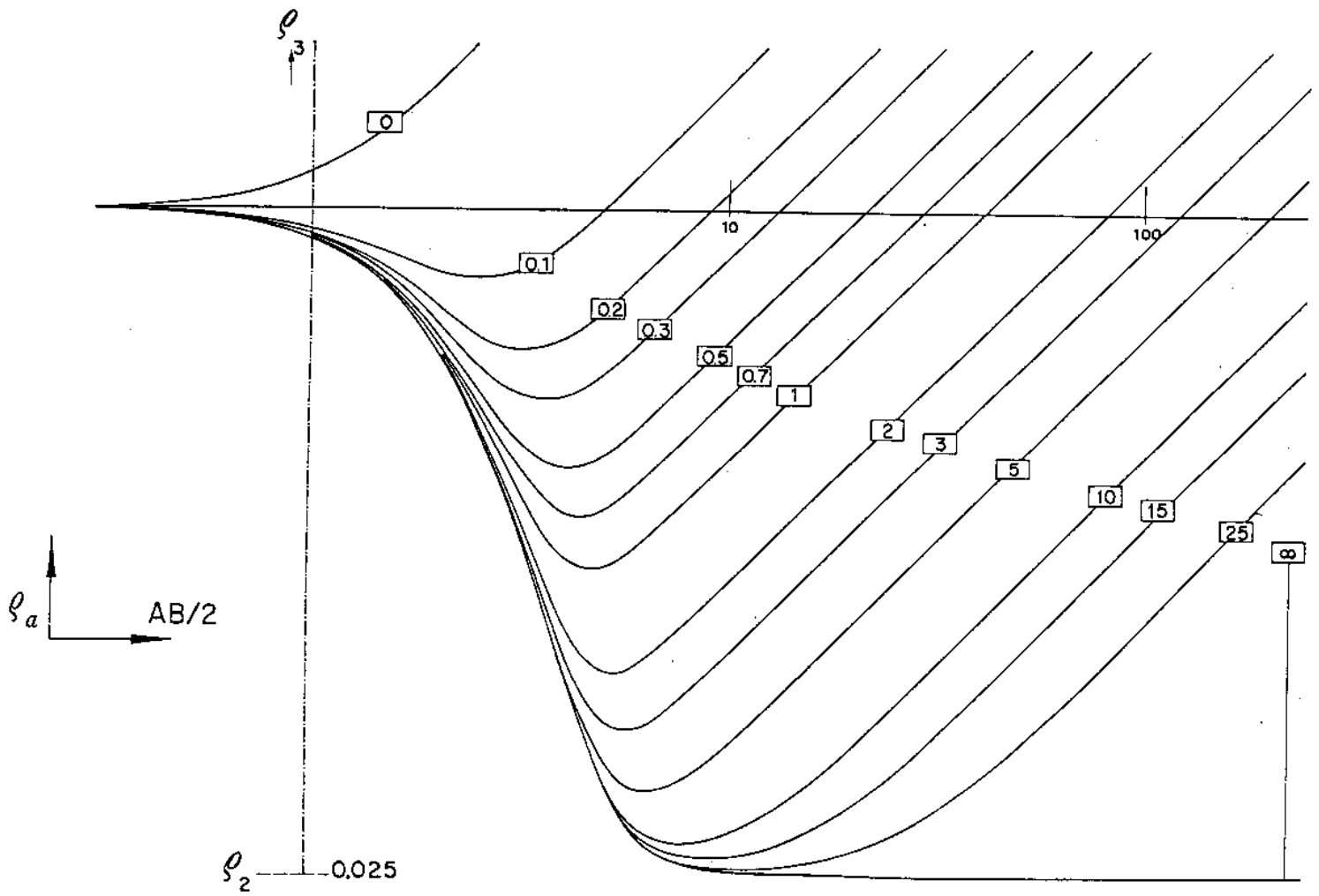

ORELLANA - MOONEY
MASTER CURVES FOR V.E.S.
CURVAS PATRON PARA SEV.

$$E_1 = 1; \rho_1 = 1; E_2 = \square$$

K-1

1-1.5-0

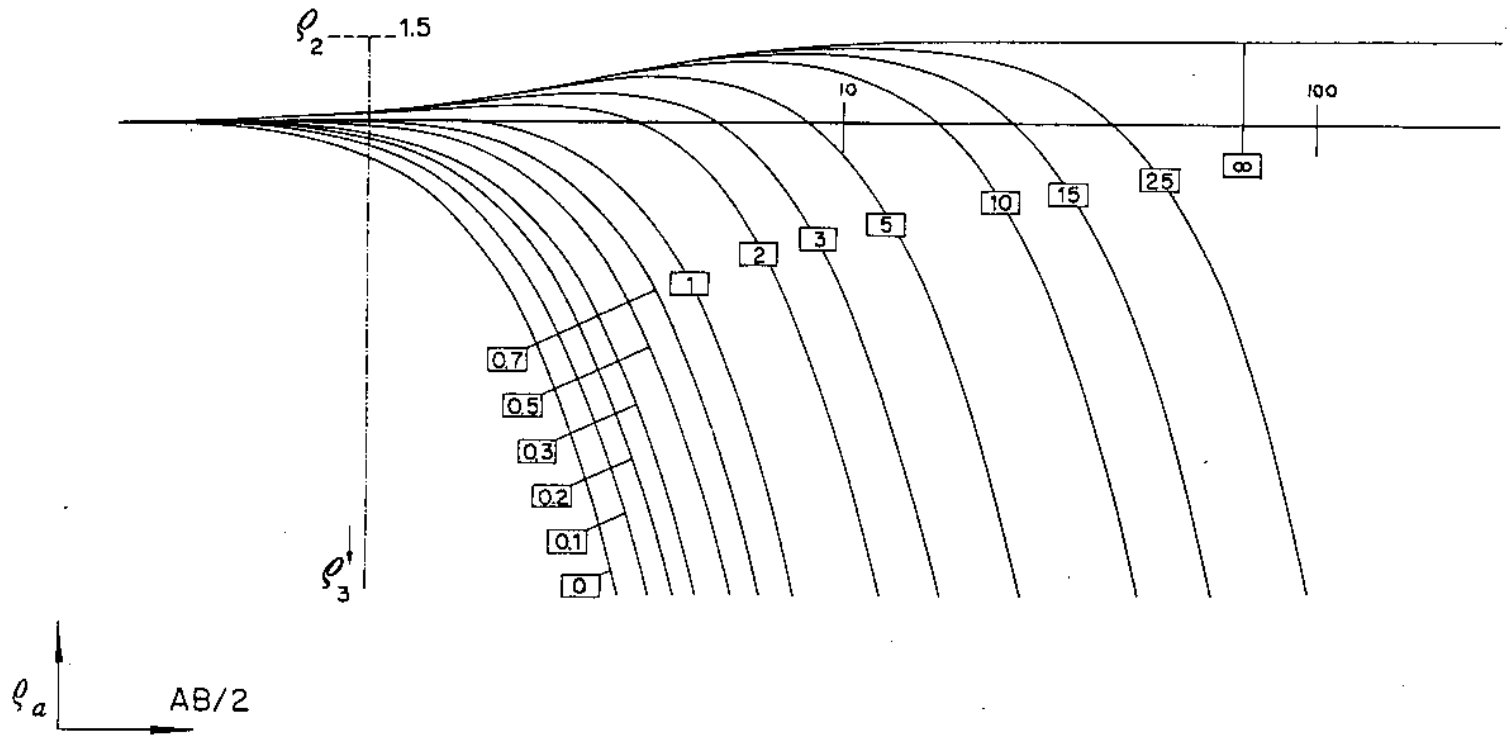

K-2

1-1.5-0.2

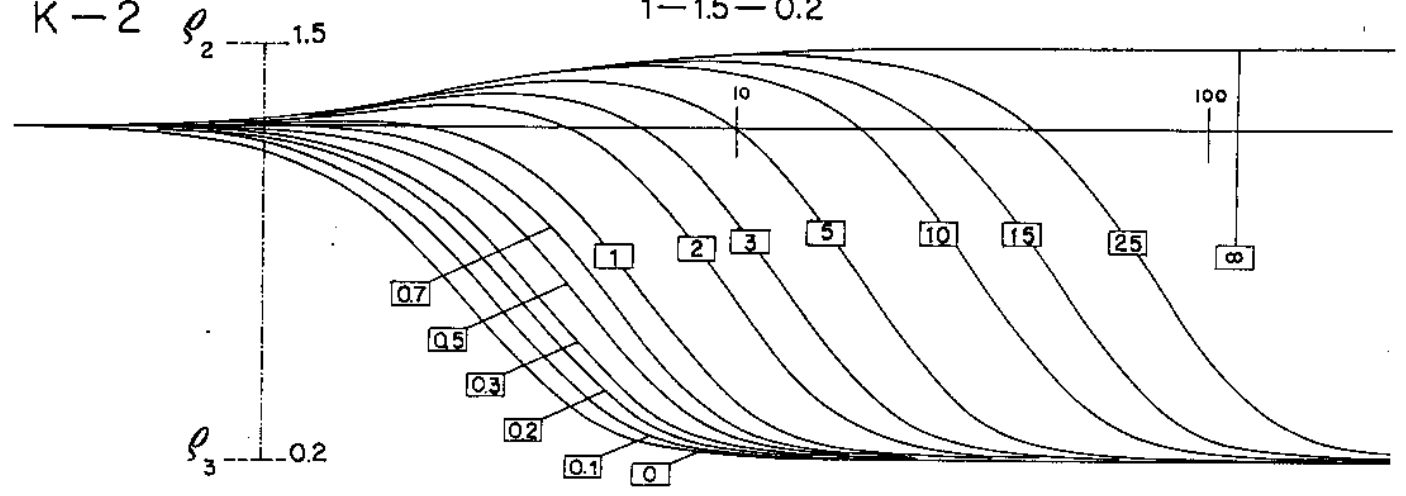

K-3

1-1.5-1

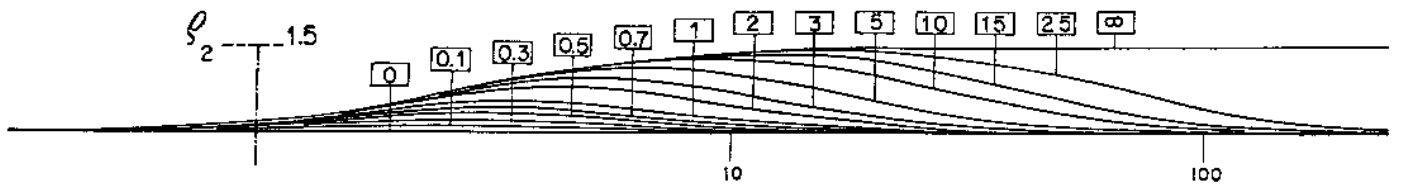

ORELLANA - MOONEY
 MASTER CURVES FOR νs.
 CURVAS PATRON PARA νs.

$$E_1 = 1; \nu_1 = 1; E_2 = \square$$

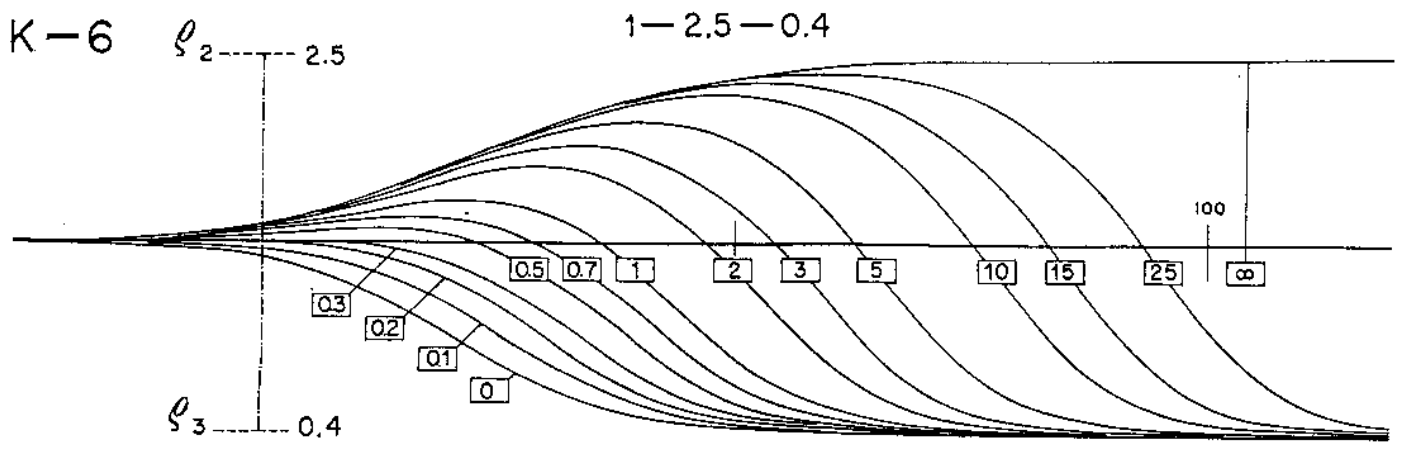
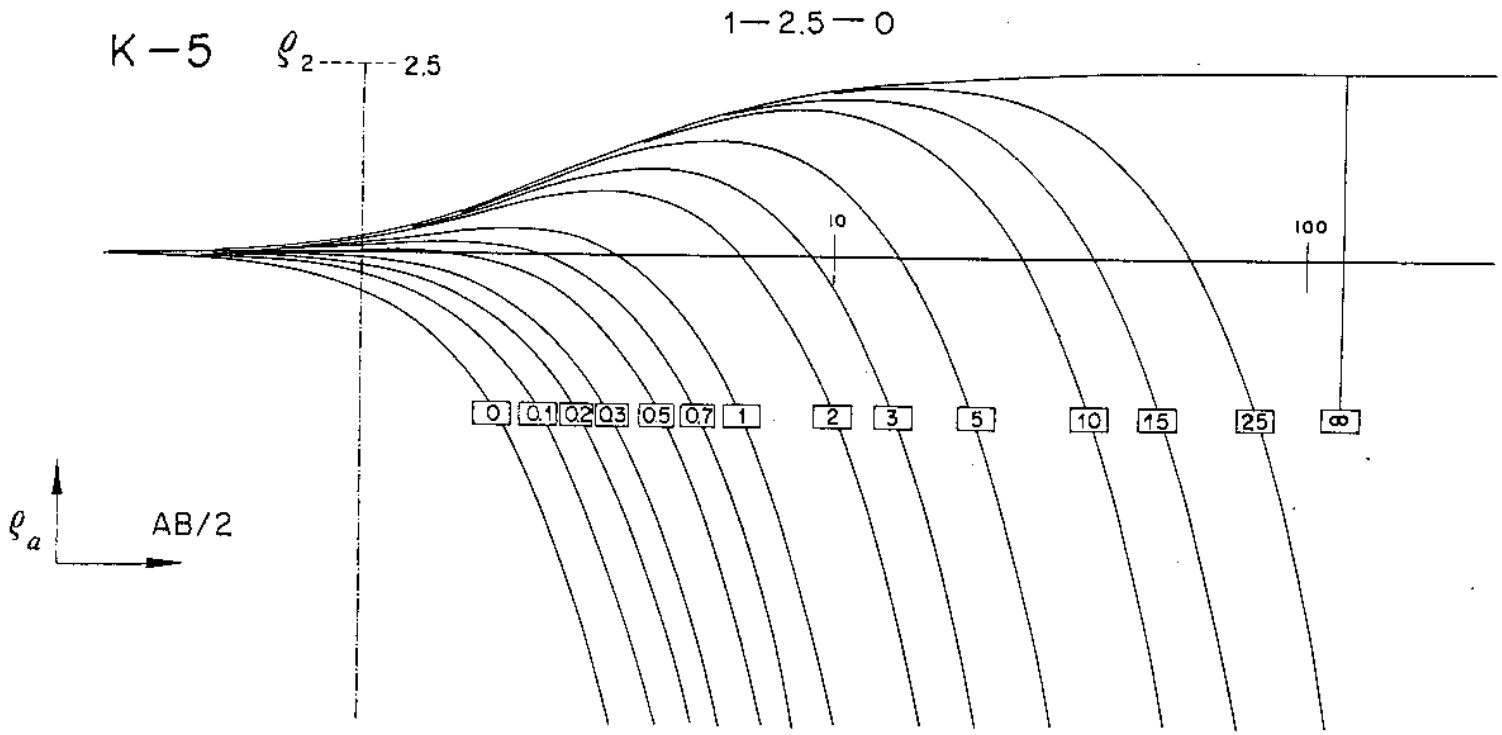
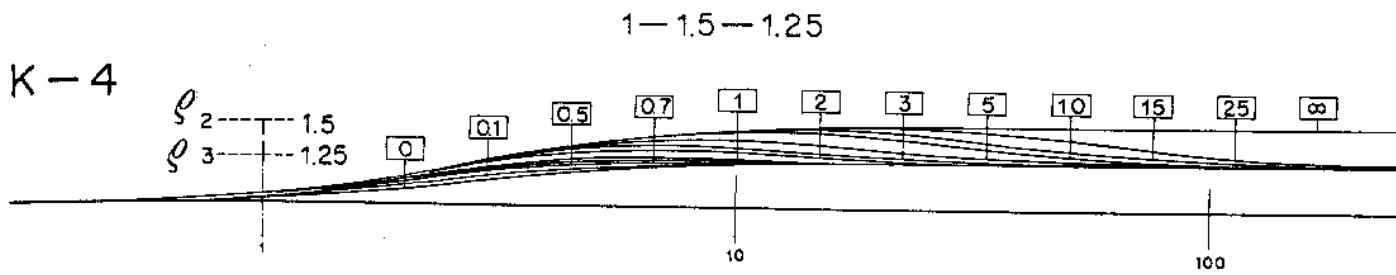

ORELLANA — MOONEY
MASTER CURVES FOR V.E.S.
CURVAS PATRON PARA SEV.

$E_1 = 1; l_1 = 1; E_2 = \square$

K-7

1-2.5-1

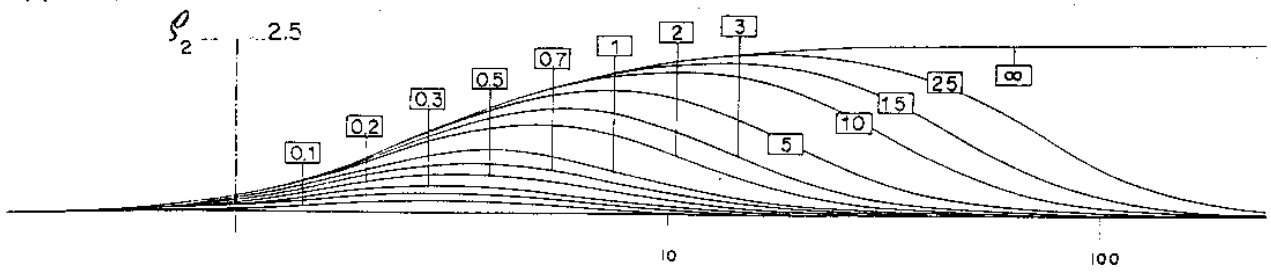

K-8

1-2.5-1.5

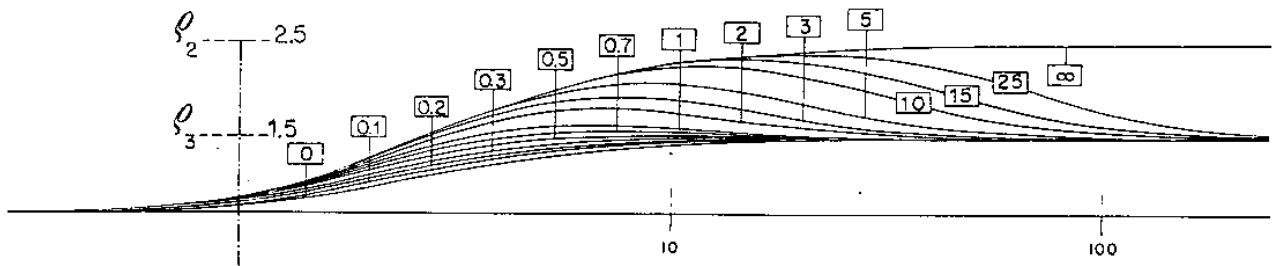

ρ_a AB/2

1-5-0

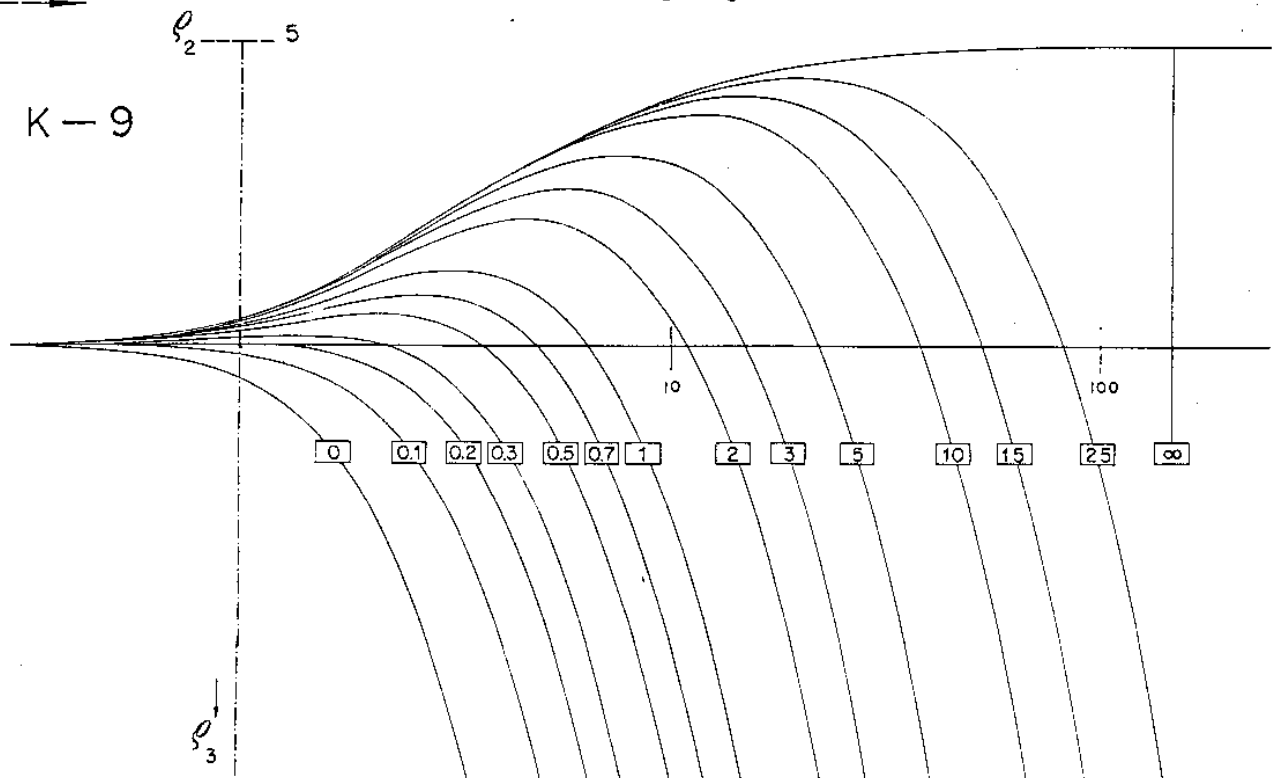

ORELLANA — MOONEY
 MASTER CURVES FOR VES.
 CURVAS PATRON PARA SEV.

$$E_1 = 1; \rho_1 = 1; E_2 = \square$$

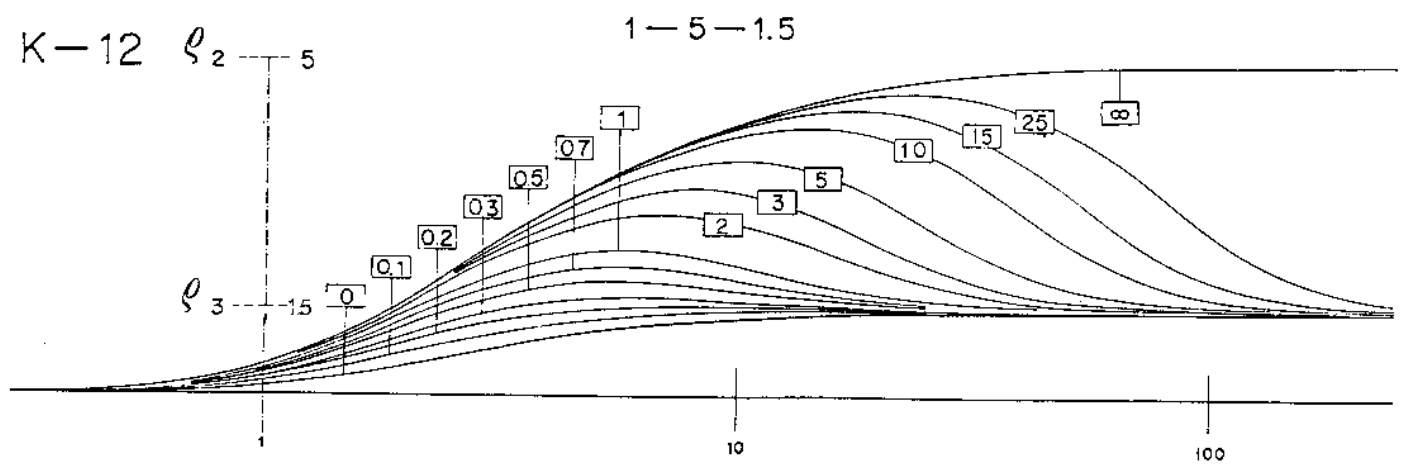
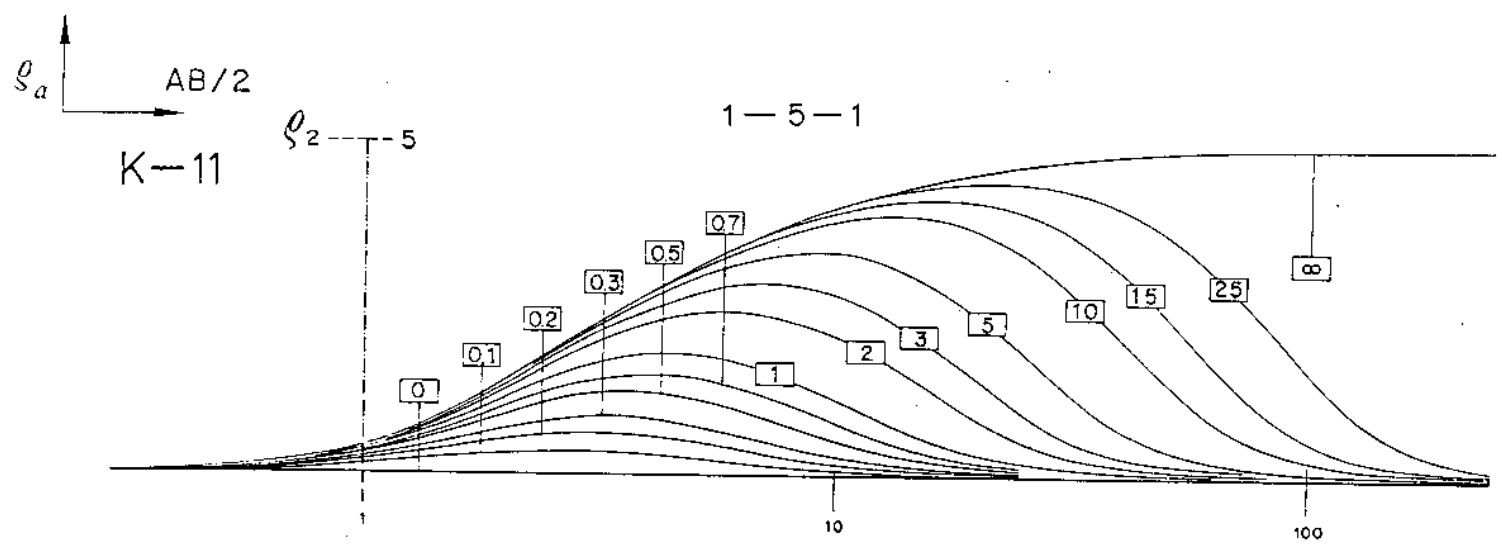
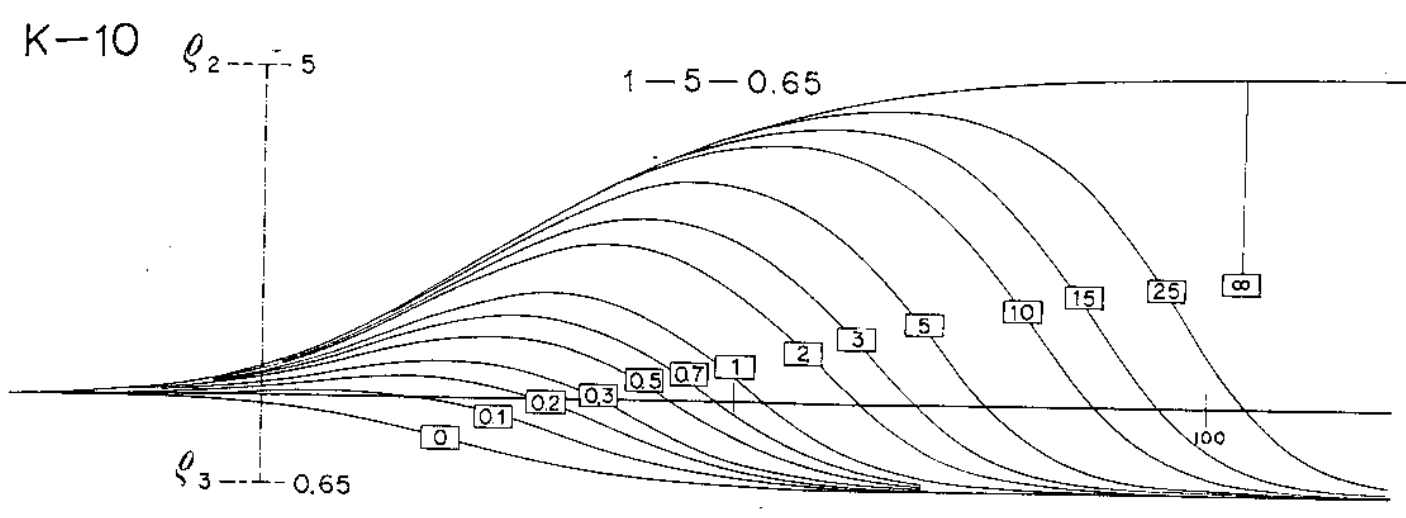

ORELLANA -- MOONEY
 MASTER CURVES FOR VES
 CURVAS PATRON PARA SEV.

$$E_1 = 1; \rho_1 = 1; E_2 = \square$$

K-13

1-5-2.5

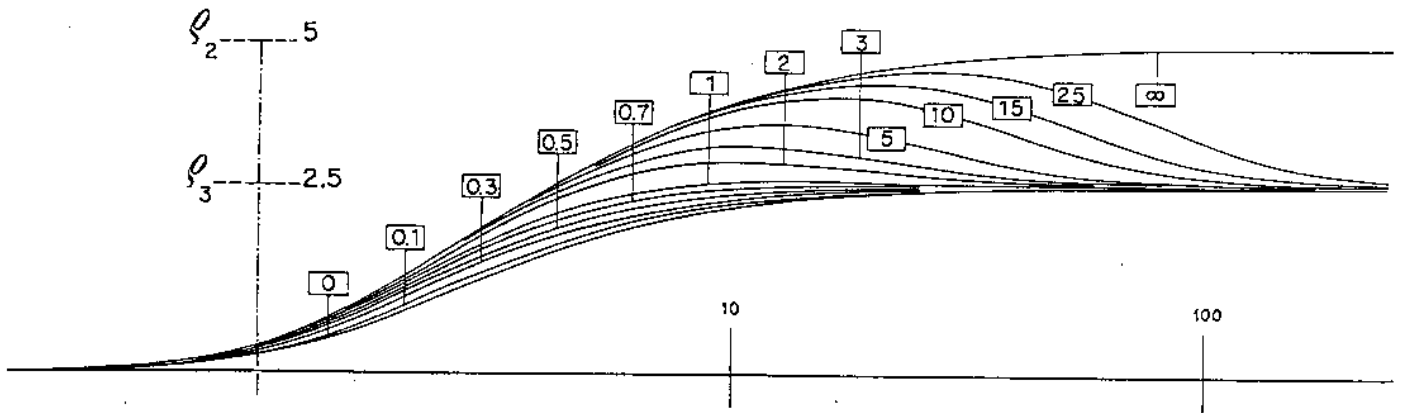

ρ_a \rightarrow AB/2

1-10-0

K-14

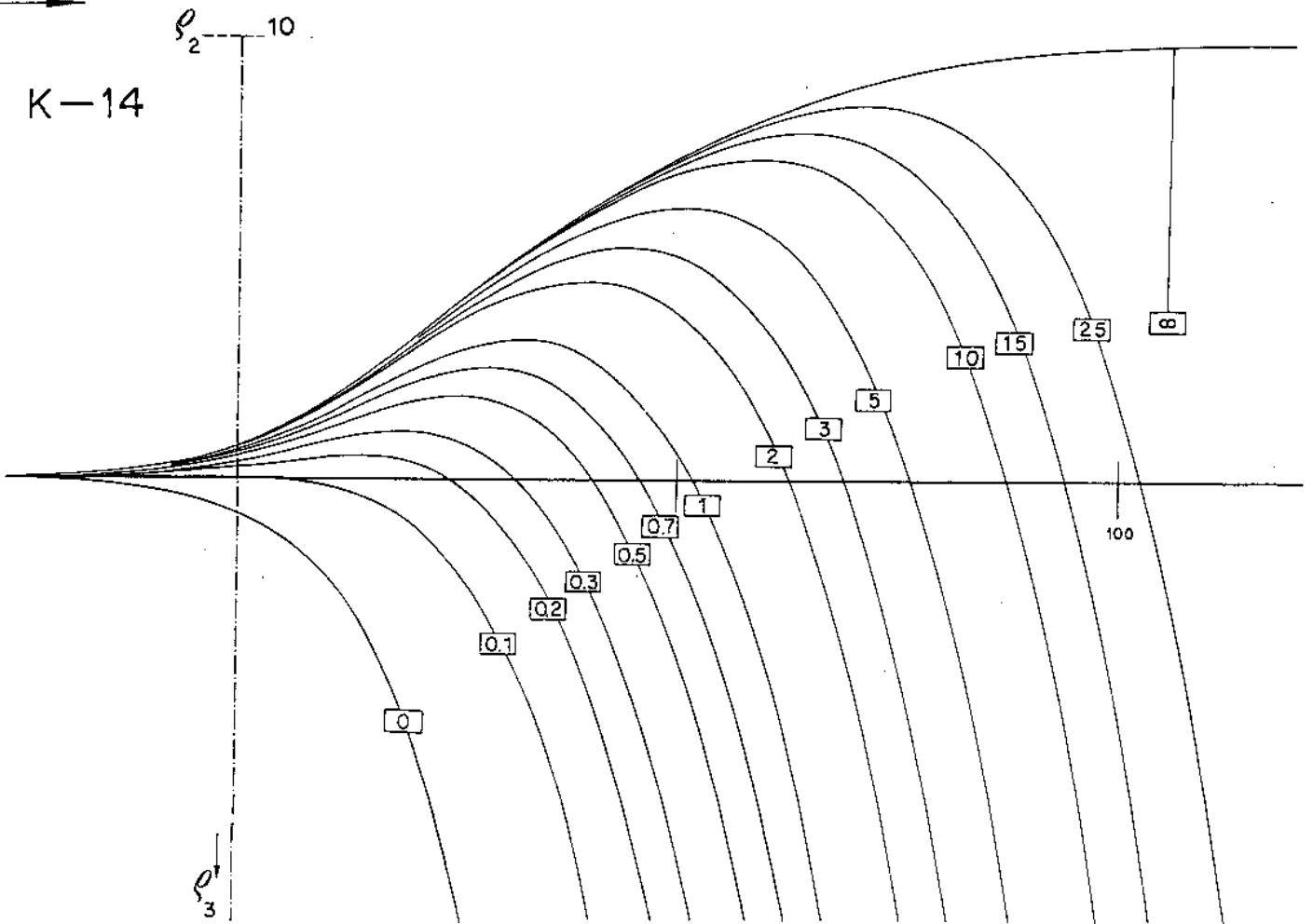

ORELLANA — MOONEY
 MASTER CURVES FOR VES
 CURVAS PATRON PARA SEV

$E_1 = 1; \rho_1 = 1; E_2 = \square$

K-15

1-10-1

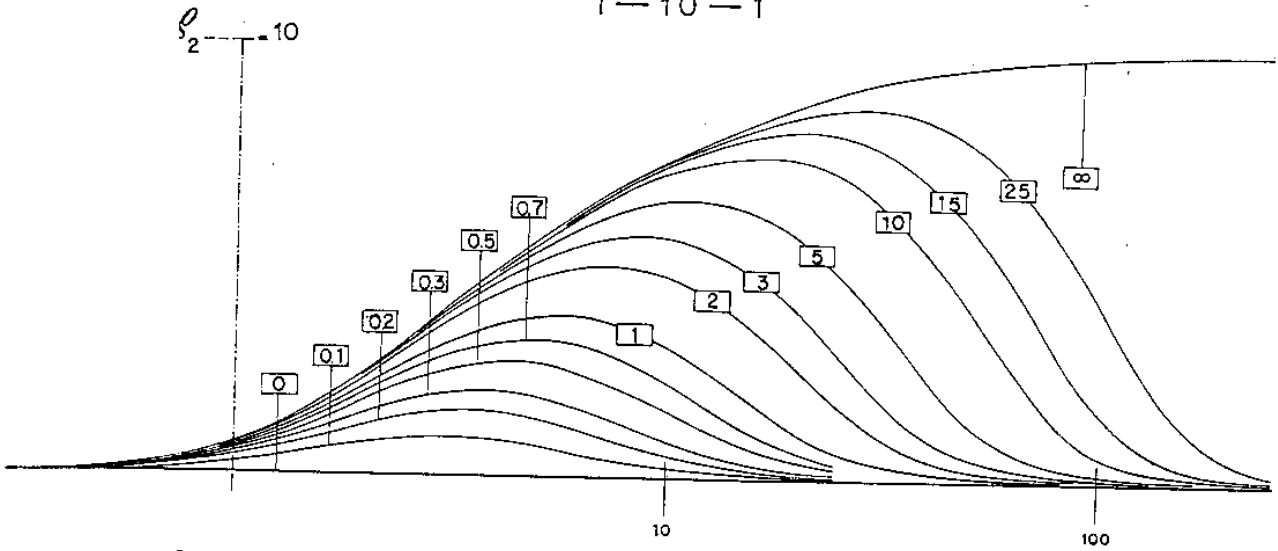

K-16

1-10-2.5

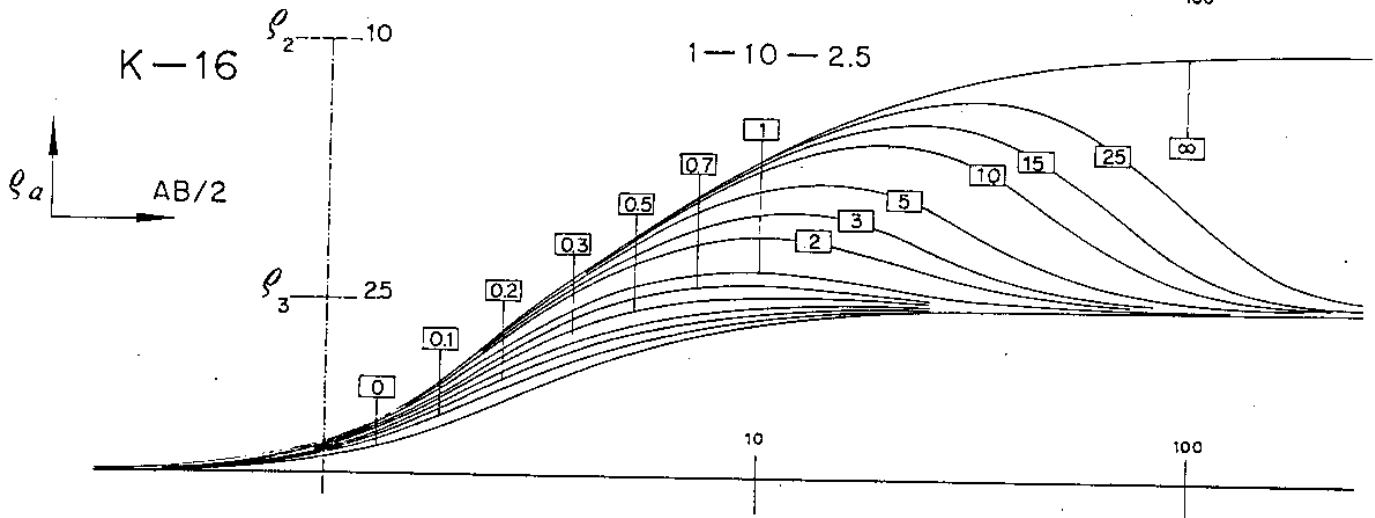

K-17

1-10-5

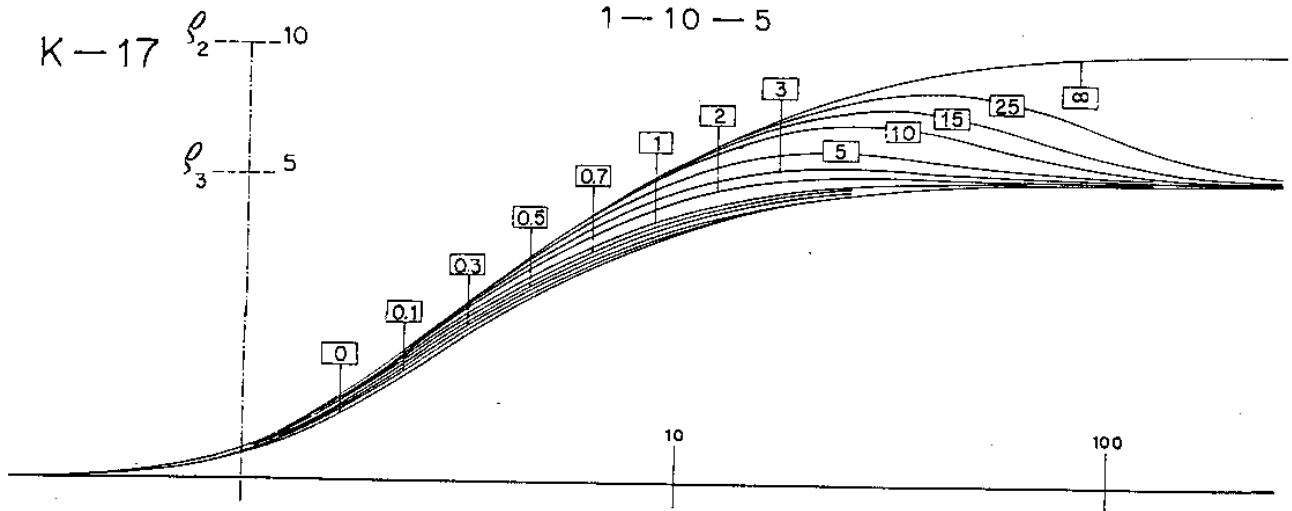

ORELLANA — MOONEY
 MASTER CURVES FOR ν.S.
 CURVAS PATRON PARA S.E.V

$$E_1 = 1; \nu_1 = 1; E_2 = \square$$

K-18

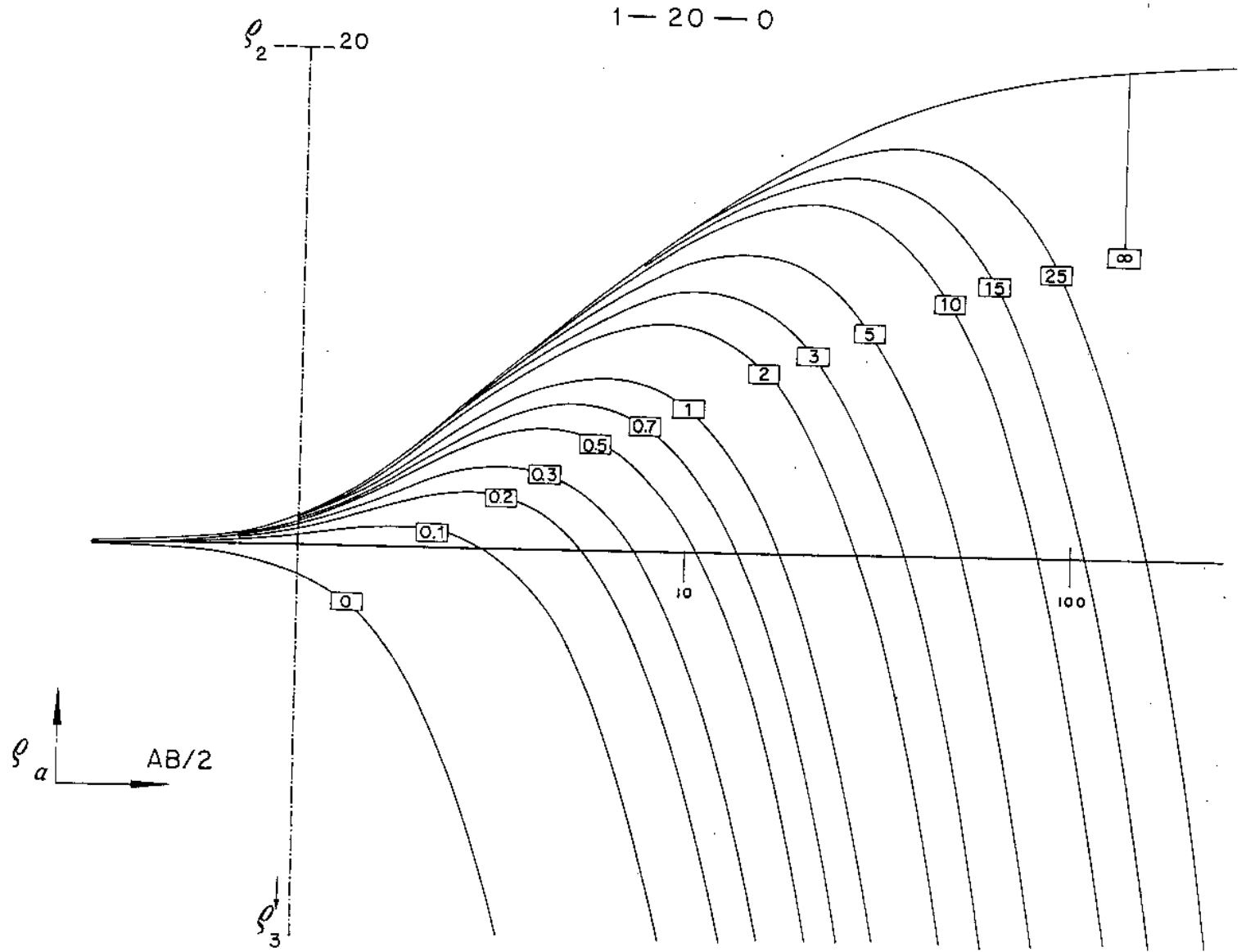

ORELLANA — MOONEY
MASTER CURVES FOR V.E.S.
CURVAS PATRON PARA SEV.

K-19

1-20-1

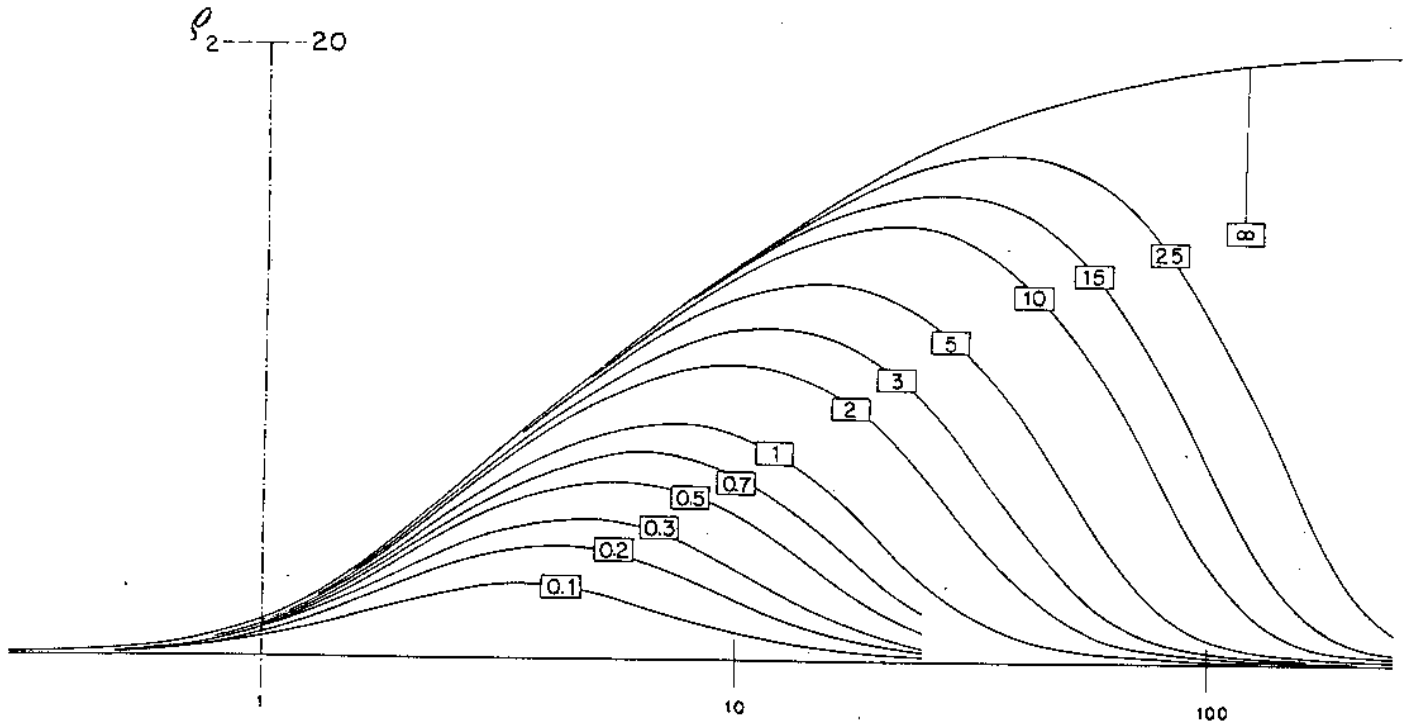

ρ_a
AB/2

1-20-5

K-20

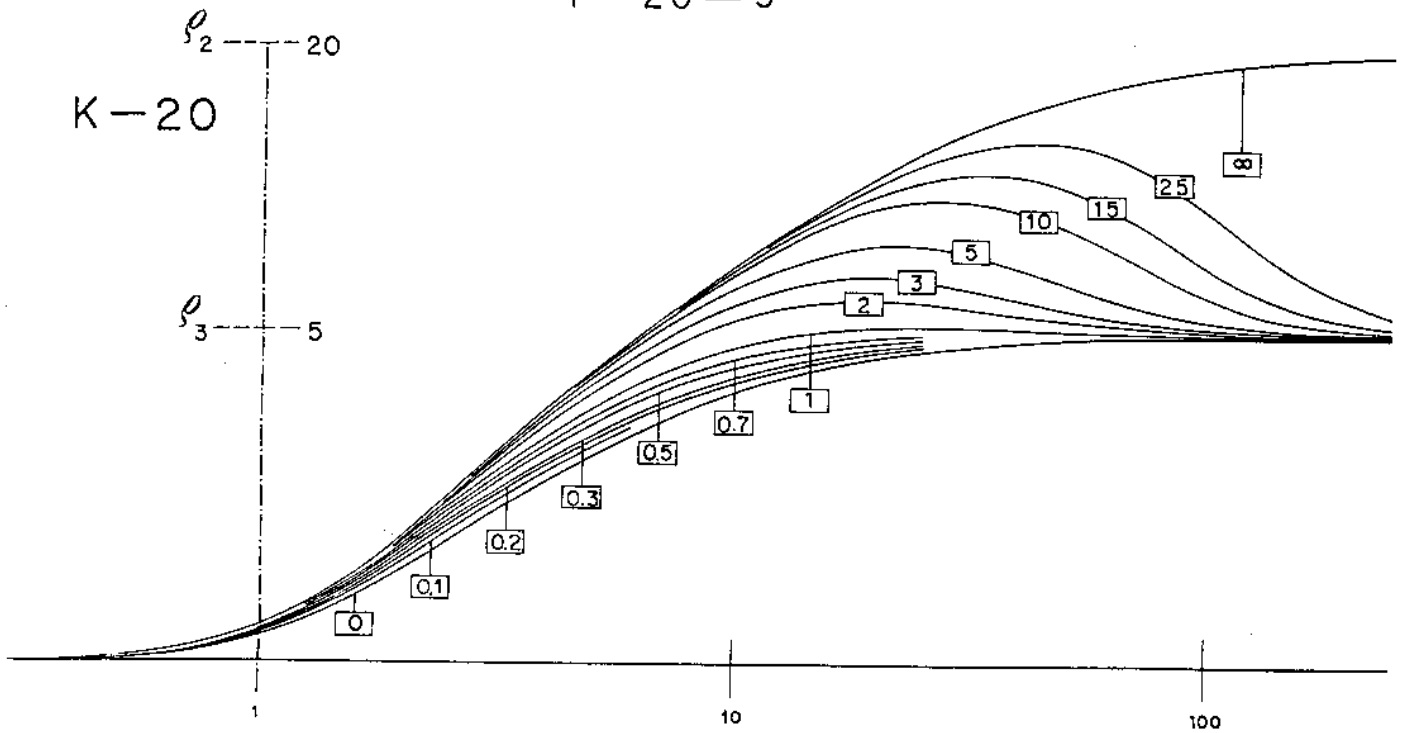

ORELLANA — MOONEY
MASTER CURVES FOR V.E.S.
CURVAS PATRON PARA SEV.

$$E_1 = 1; \rho_1 = 1; E_2 = \square$$

K-21

1-20-10

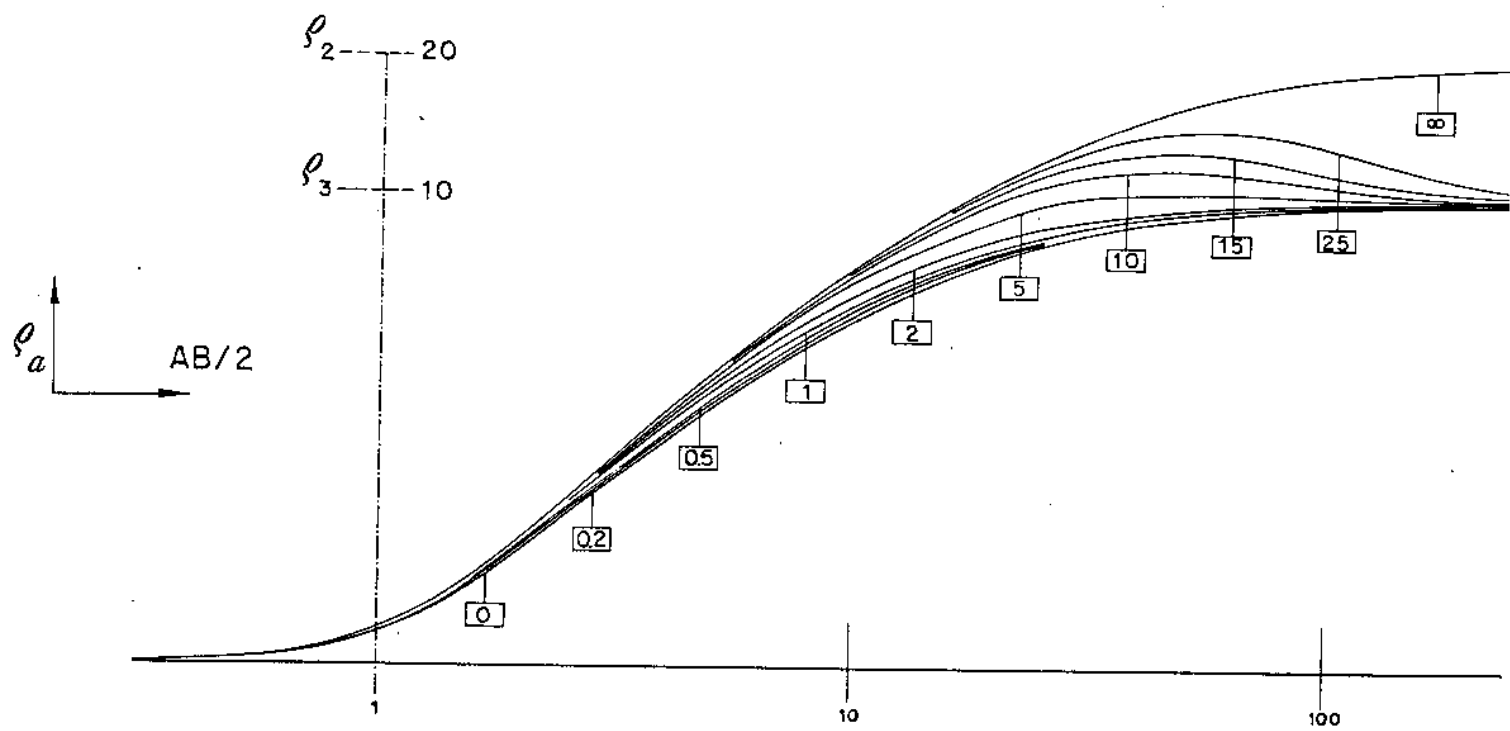

ORELLANA - MOONEY
MASTER CURVES FOR V.E.S.
CURVAS PATRON PARA S.E.V.

$$E_1 = 1; \rho_1 = 1; E_2 = \square$$

K-22

1-40-0

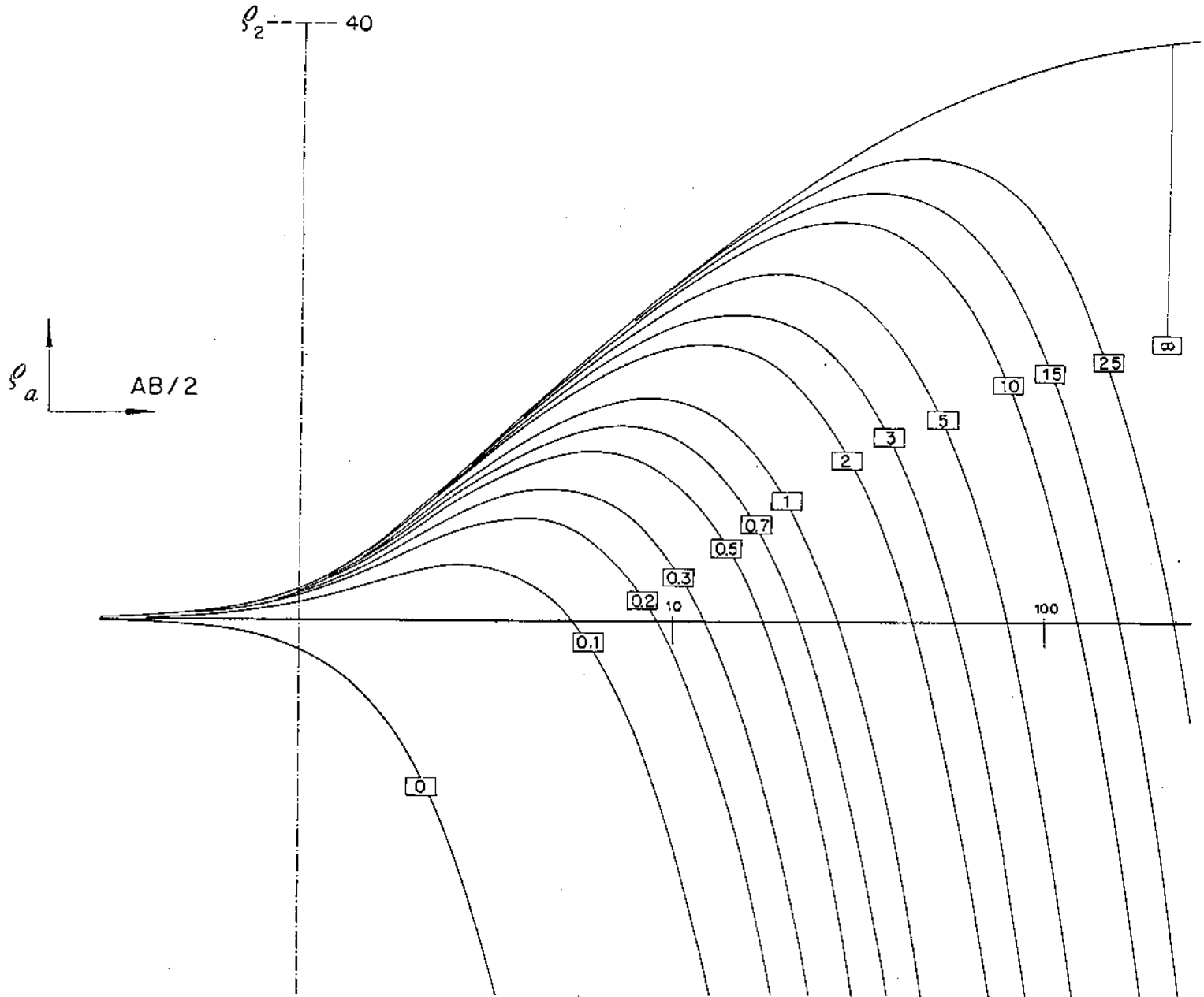

ORELLANA - MOONEY
MASTER CURVES FOR V.S.
CURVAS PATRON PARA SEV.

$$E_1 = 1; \rho_1 = 1; E_2 = \square$$

K-23

1-40-1

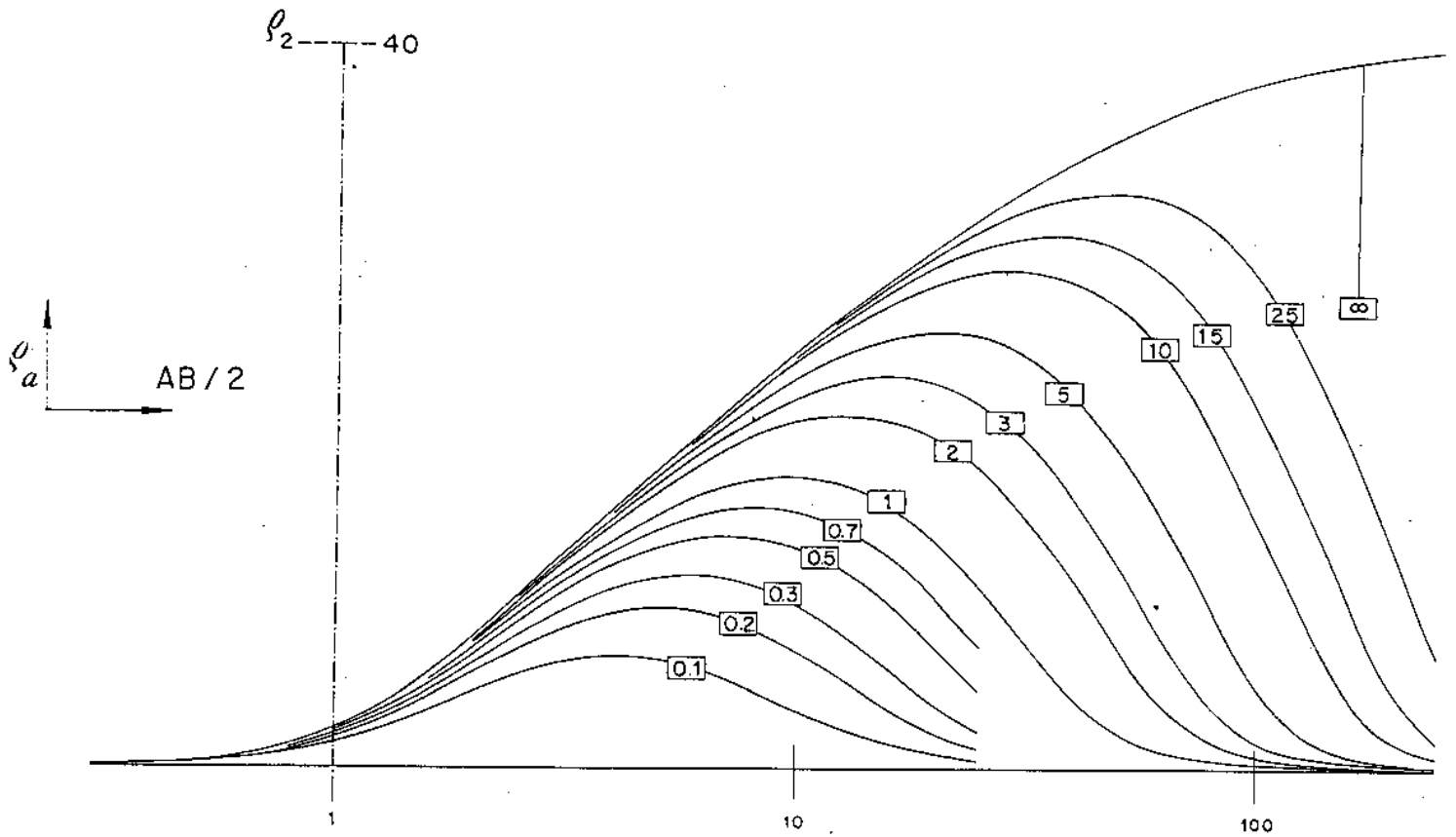

ORELLANA — MOONEY
MASTER CURVES FOR VES
CURVAS PATRON PARA SEV.

$$E_1 = 1; \rho_1 = 1; E_2 = \square$$

K-2.4

1-40-10

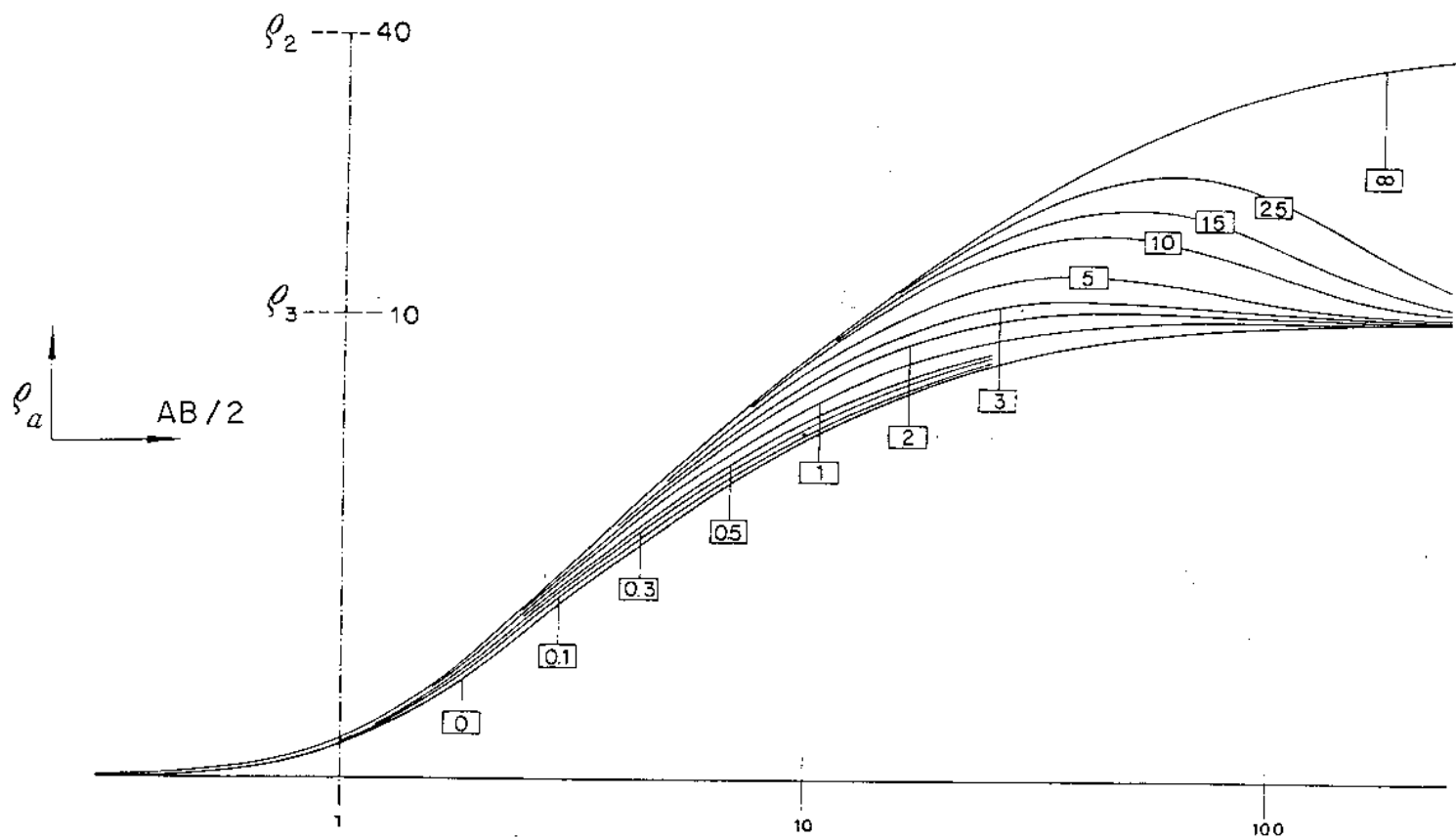

ORELLANA - MOONEY
MASTER CURVES FOR V.E.S.
CURVAS PATRON PARA SEV.

$$E_1 = 1; \rho_1 = 1; E_2 = \square$$

K-25

1-40-20

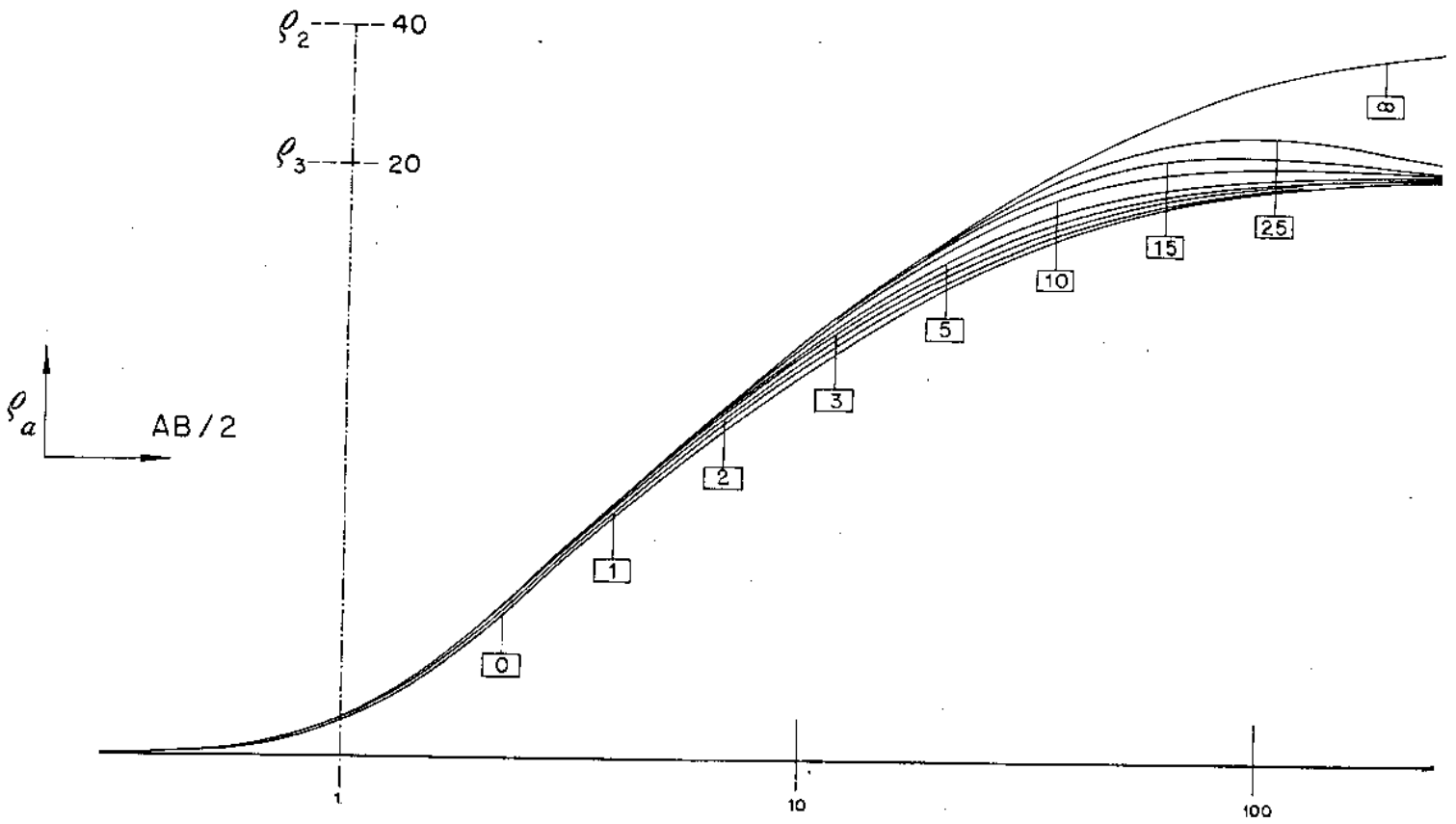

ORELLANA - MOONEY
MASTER CURVES FOR V.S.
CURVAS PATRON PARA SEV.

$$E_1 = 1; \rho_1 = 1; E_2 = \square$$

Q-1

1-0.65-0.4

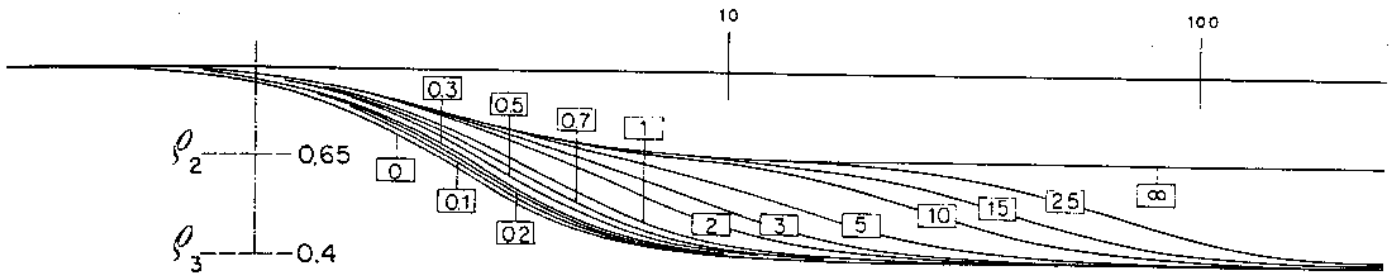

Q-2

1-0.65-0.2

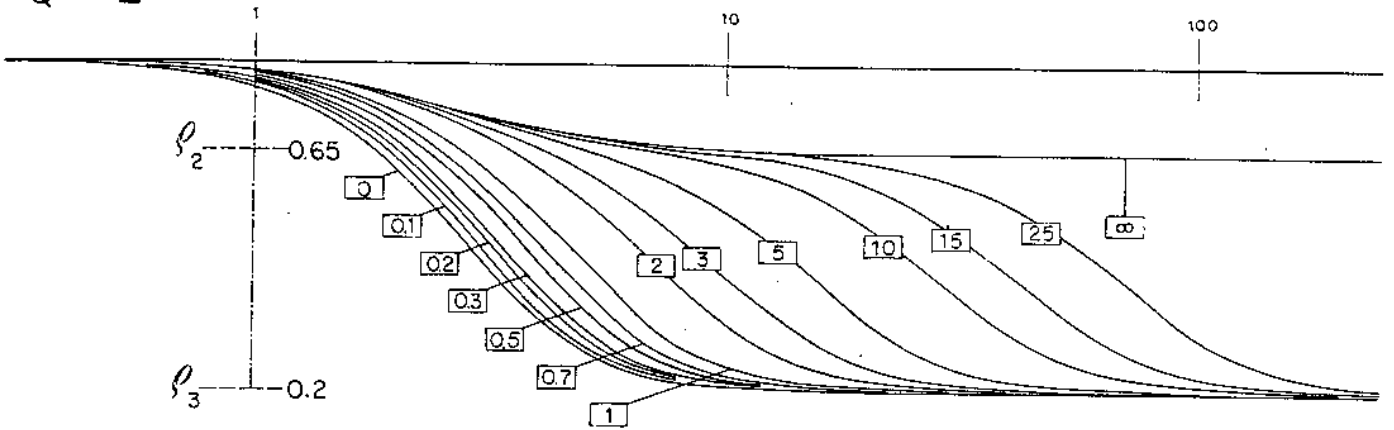

ρ_a AB/2

Q-3

1-0.65-0

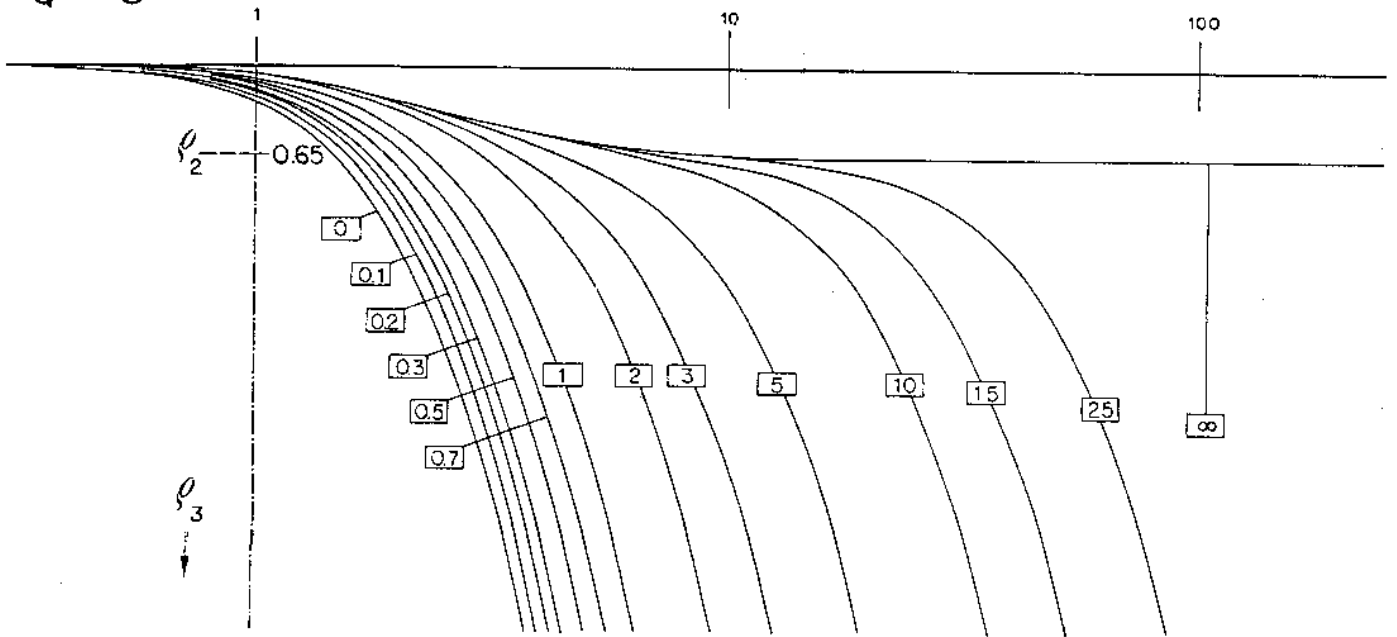

ORELLANA — MOONEY
MASTER CURVES FOR V.E.S
CURVAS PATRON PARA SEV.

$E_1 = 1; \rho_1 = 1; E_2 = \square$

Q-4

1-0.4-0.2

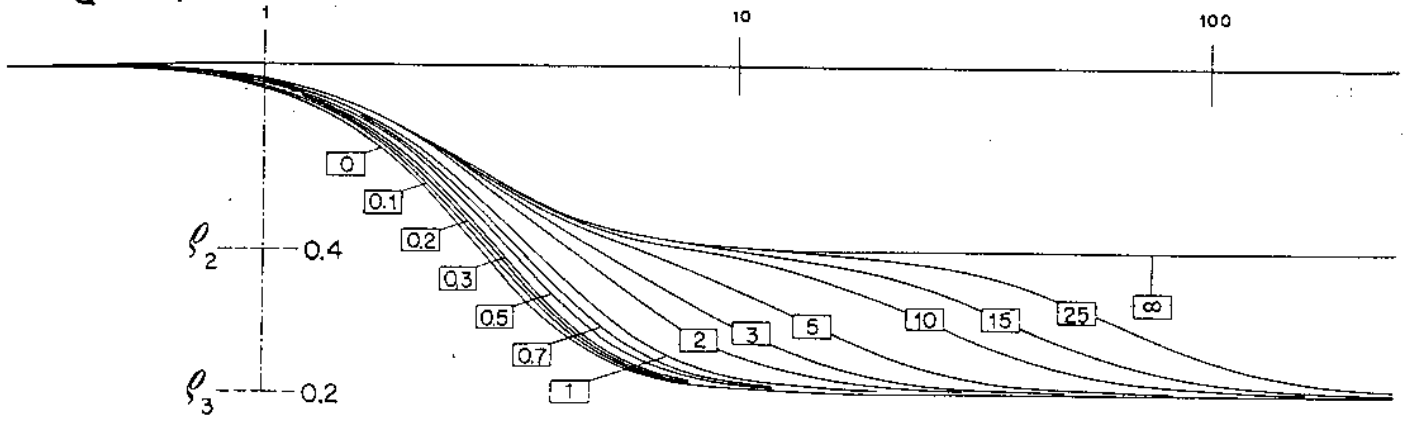

Q-5

1-0.4-0.1

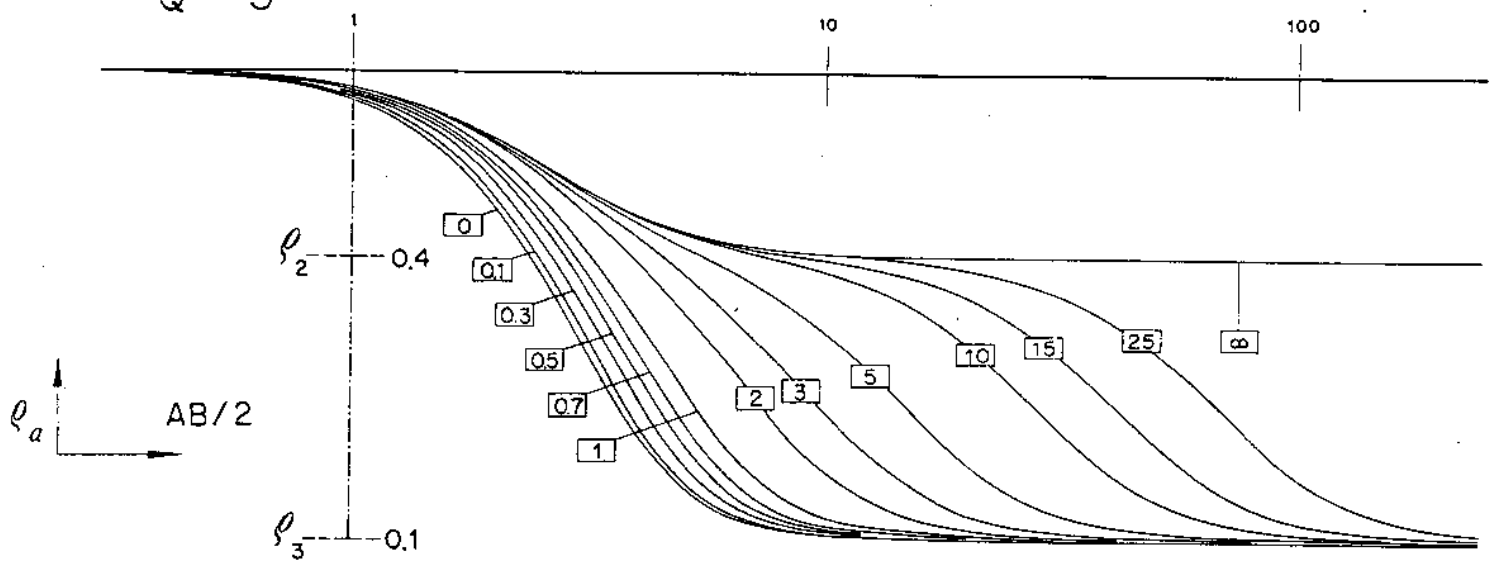

Q-6

1-0.4-0

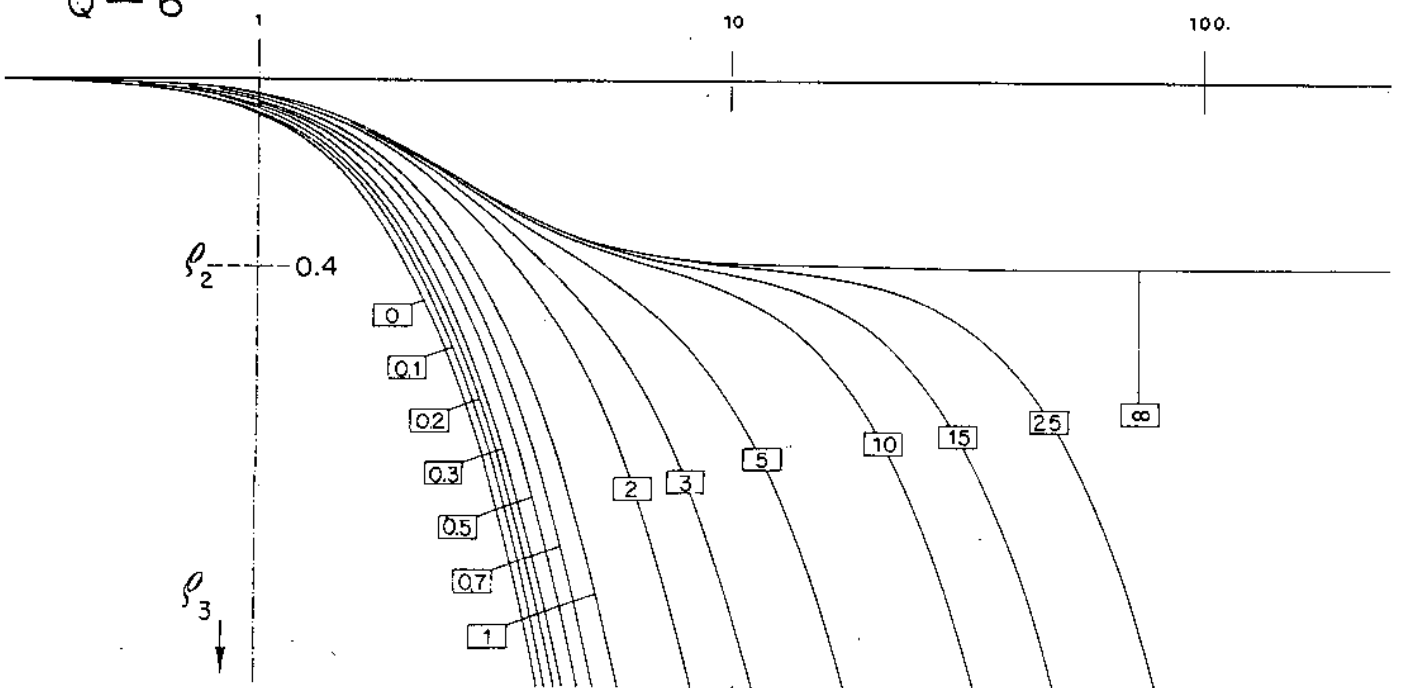

ORELLANA-MOONEY
MASTER CURVES FOR V.E.S.
CURVAS PATRON PARA SEV.

$E_1 = 1; \rho_1 = 1; E_2 = \square$

Q-7

1-0.2-0.1

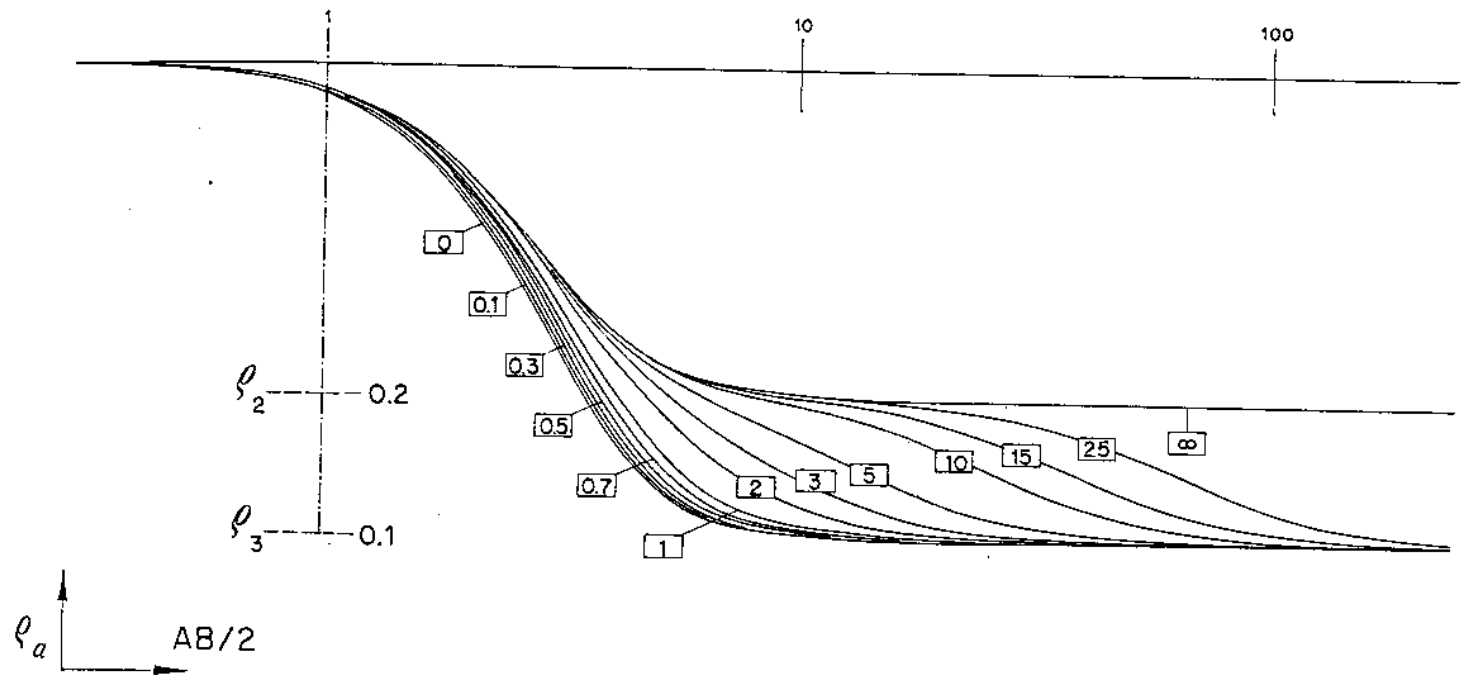

Q-8

1-0.2-0.05

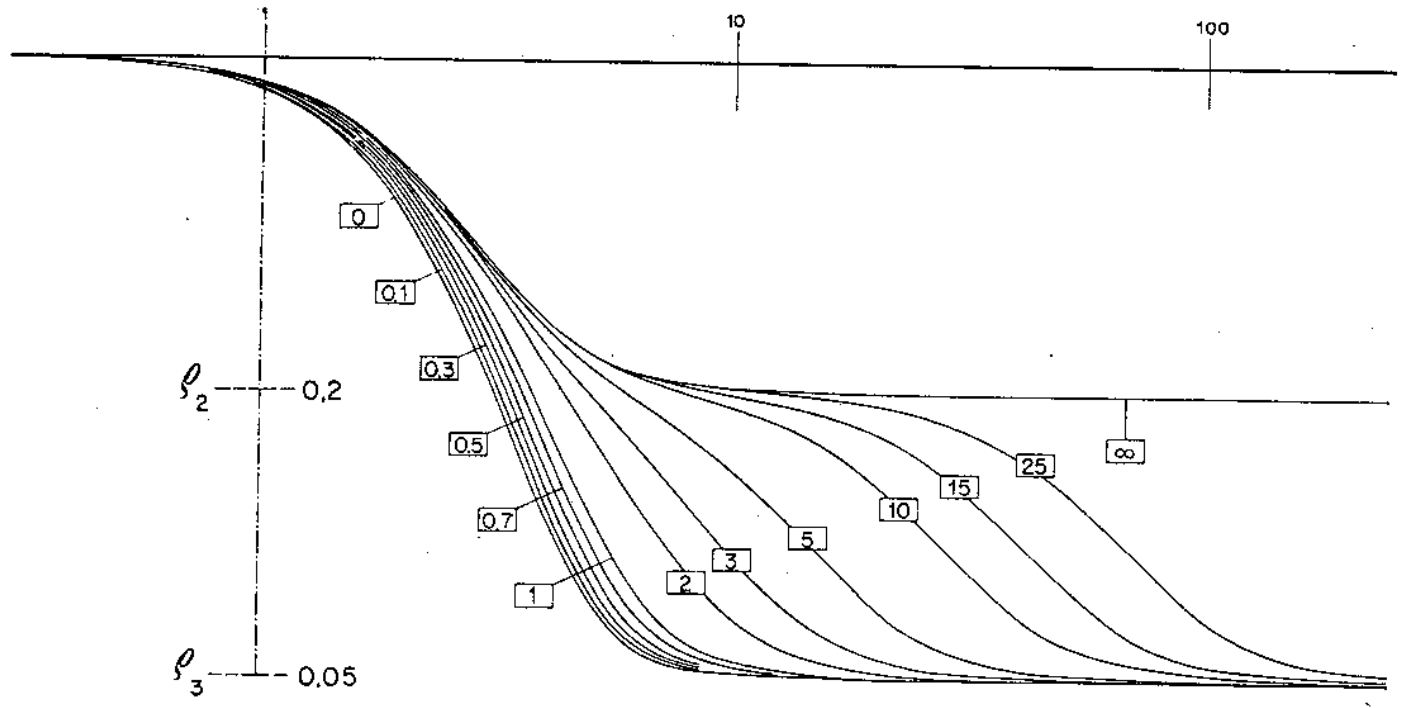

$$E_1 = 1; \rho_1 = 1; E_2 = \square$$

ORELLANA — MOONEY
 MASTER CURVES FOR VES.
 CURVAS PATRON PARA SEV.

Q-9

1-0.2-0

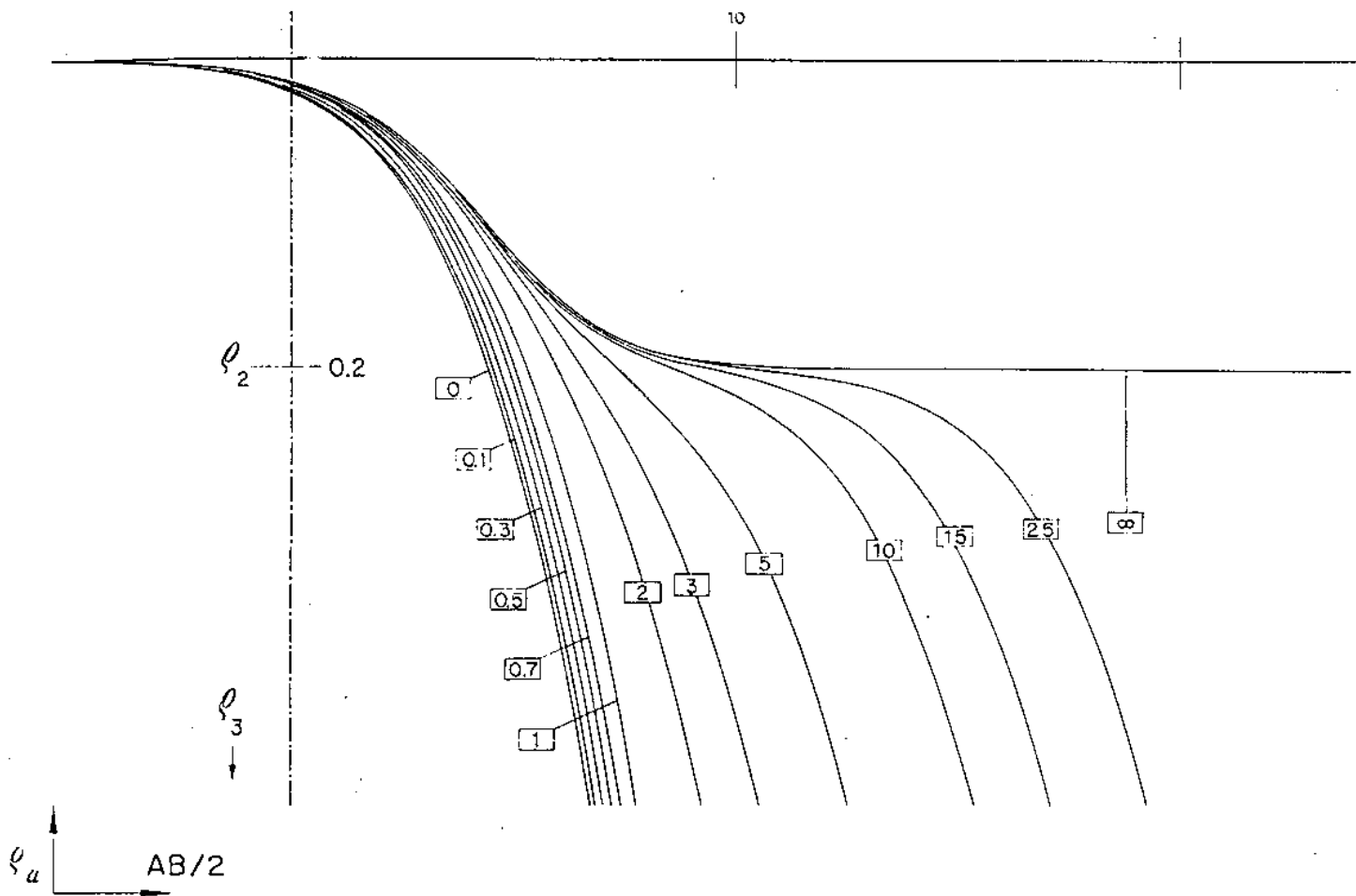

Q-10

1-0.1-0.05

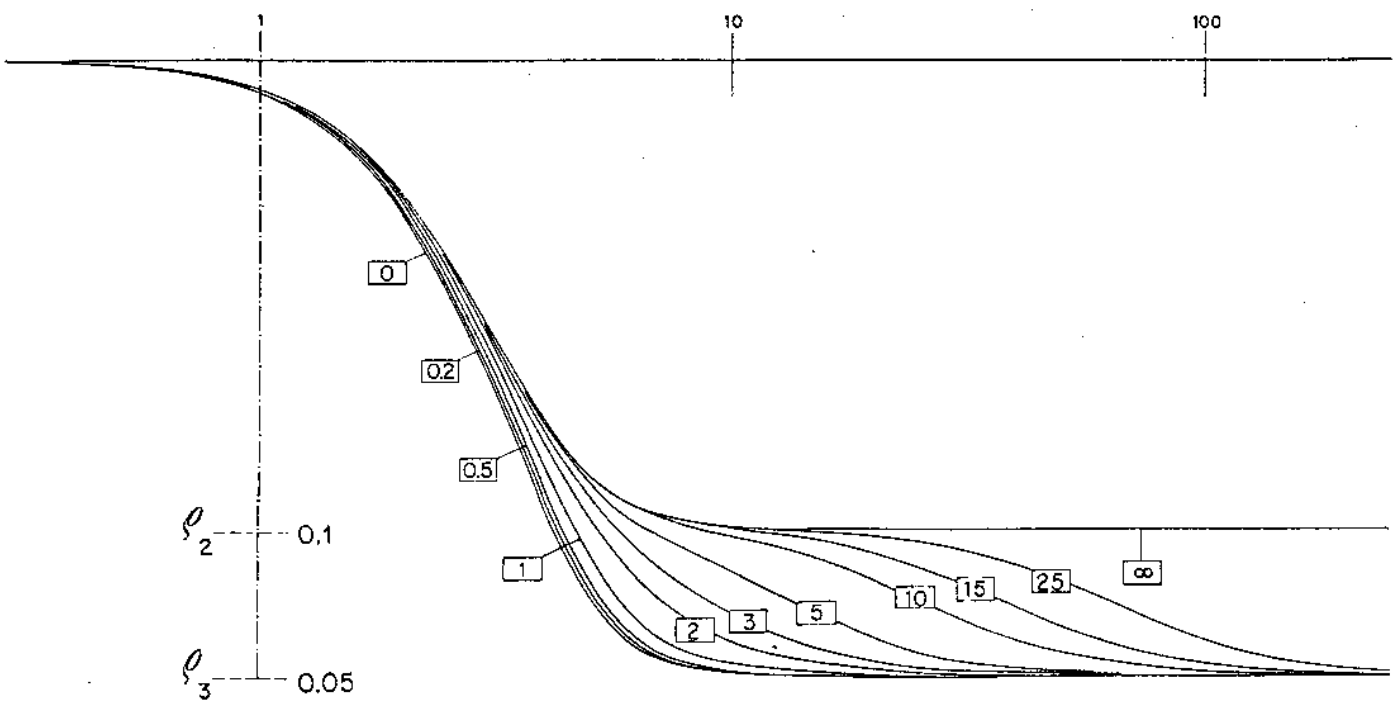

ORELLANA — MOONEY
MASTER CURVES FOR VES
CURVAS PATRON PARA SEV

$E_1 = 1; \rho_1 = 1; E_2 = \square$

Q-11

1-0.1-0

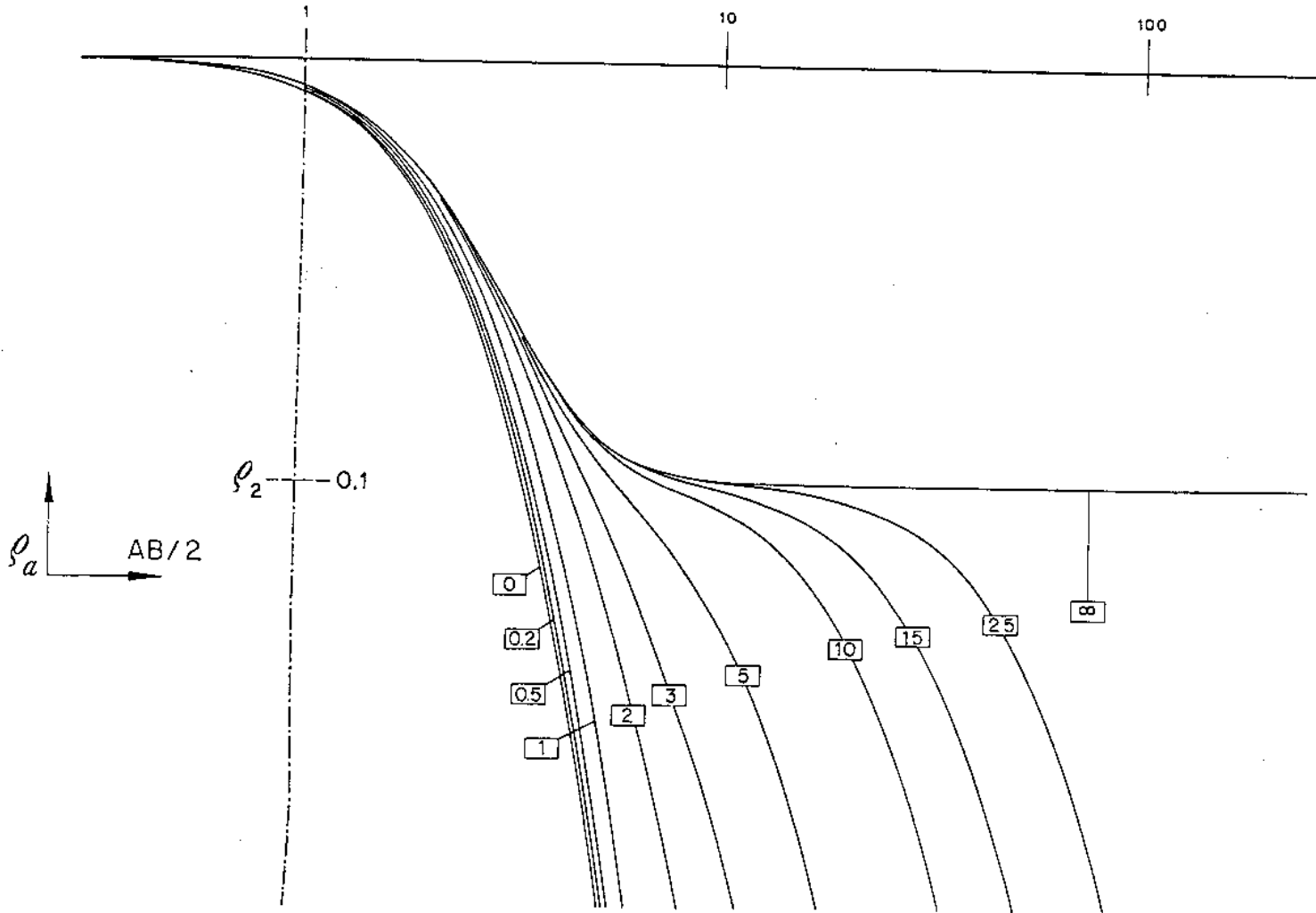

$$E_1 = 1: \rho_1 = 1: E_2 = \square$$

ORELLANA — MOONEY
MASTER CURVES FOR V.E.S.
CURVAS PATRON PARA S.E.V.

Q-12

1-0.05-0

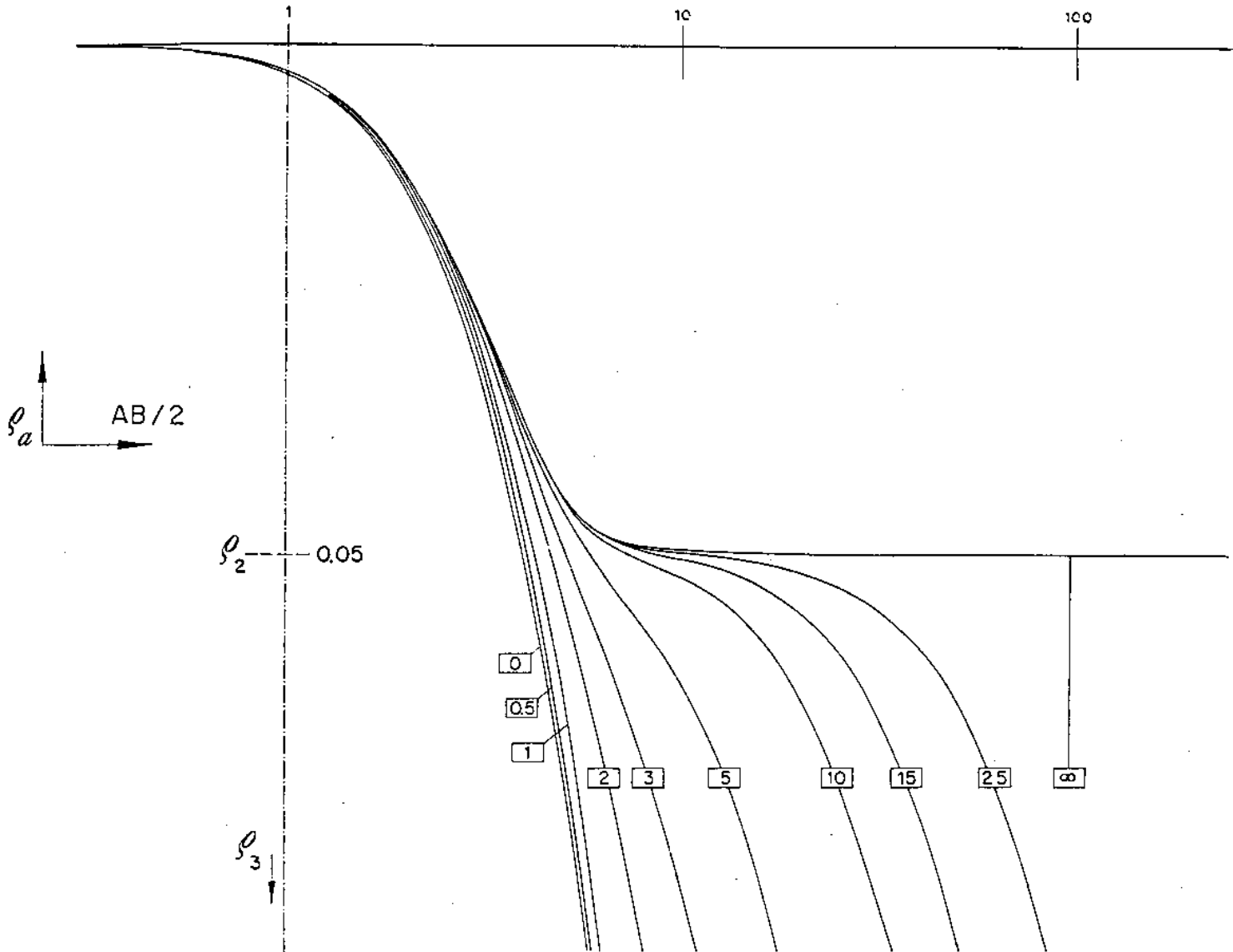

$$E_1 = 1; \rho_1 = 1; E_2 = \square$$

ORELLANA — MOONEY
MASTER CURVES FOR V.E.S.
CURVAS PATRON PARA SEV.

Q-13

1-0.025-0

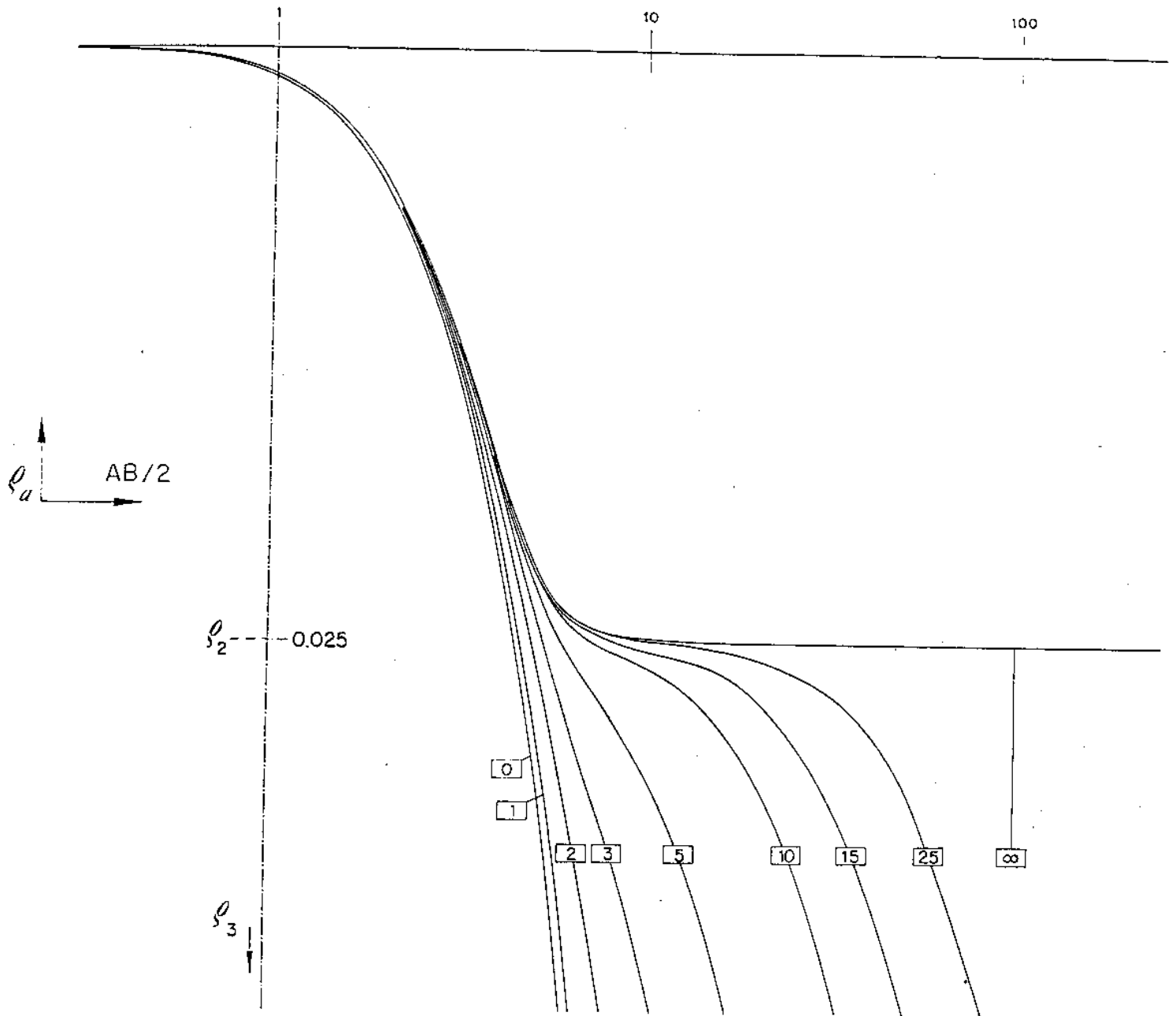

$$E_1 = 1; \rho_1 = 1; E_2 = \square$$

ORELLANA — MOONEY
MASTER CURVES FOR VES.
CURVAS PATRON PARA S.E.V.

A-1

1-1.5-2.5

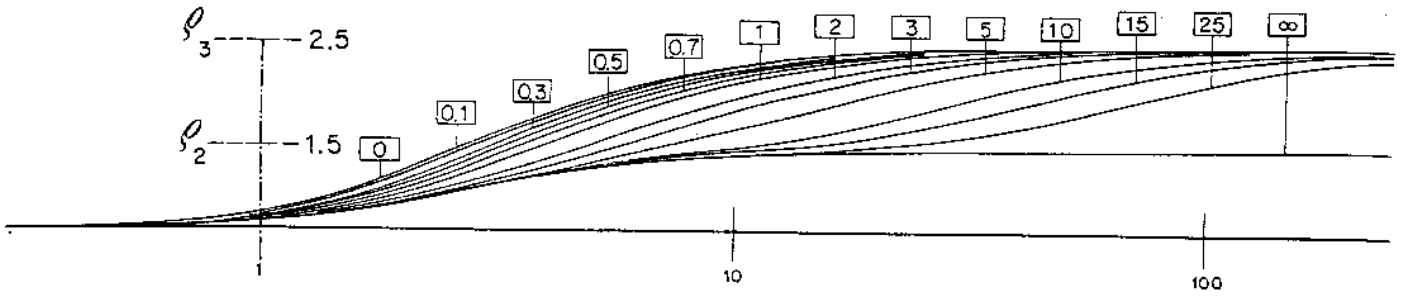

A-2

1-1.5-5

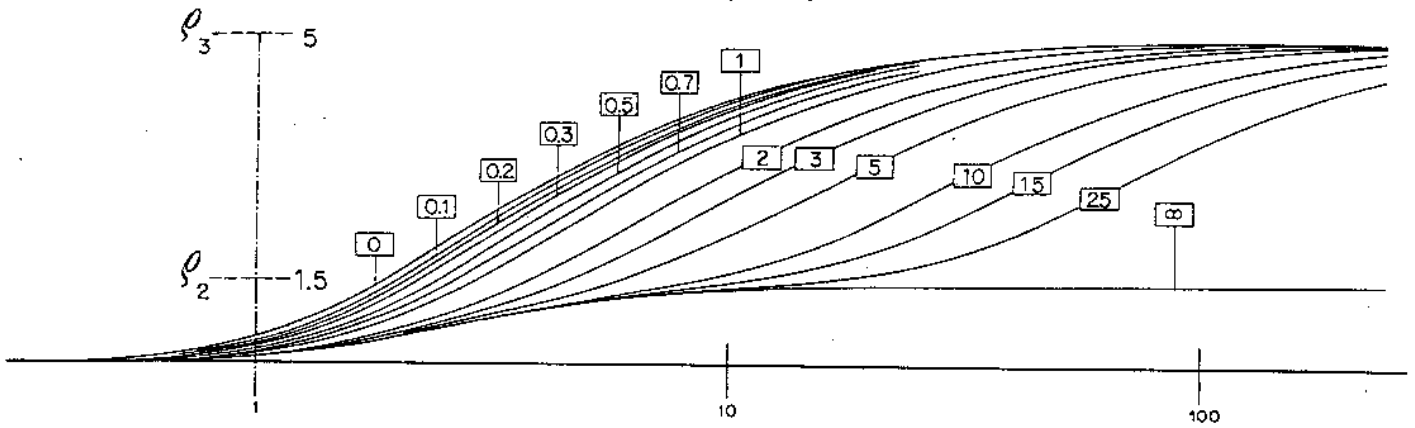

ρ_a \rightarrow AB/2

1-1.5-∞

A-3

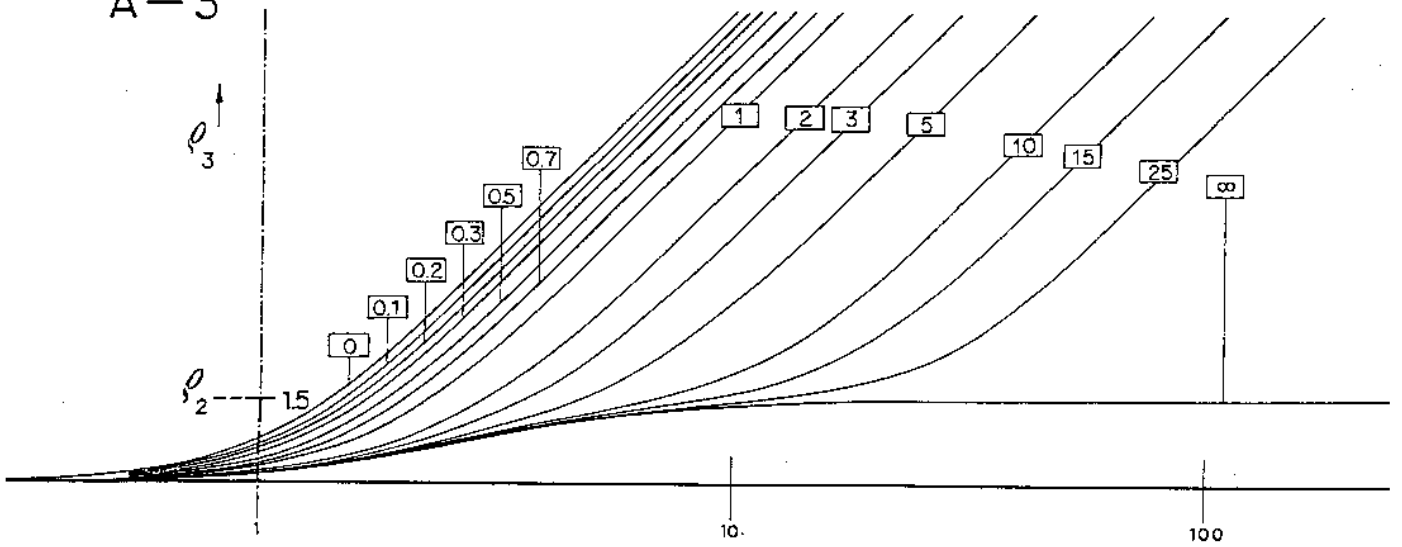

ORELLANA — MOONEY
 MASTER CURVES FOR ν=0.5.
 CURVAS PATRON PARA ν=0.5.

$$E_1 = 1; \rho_1 = 1; E_2 = \square$$

A-4

1-2.5-5

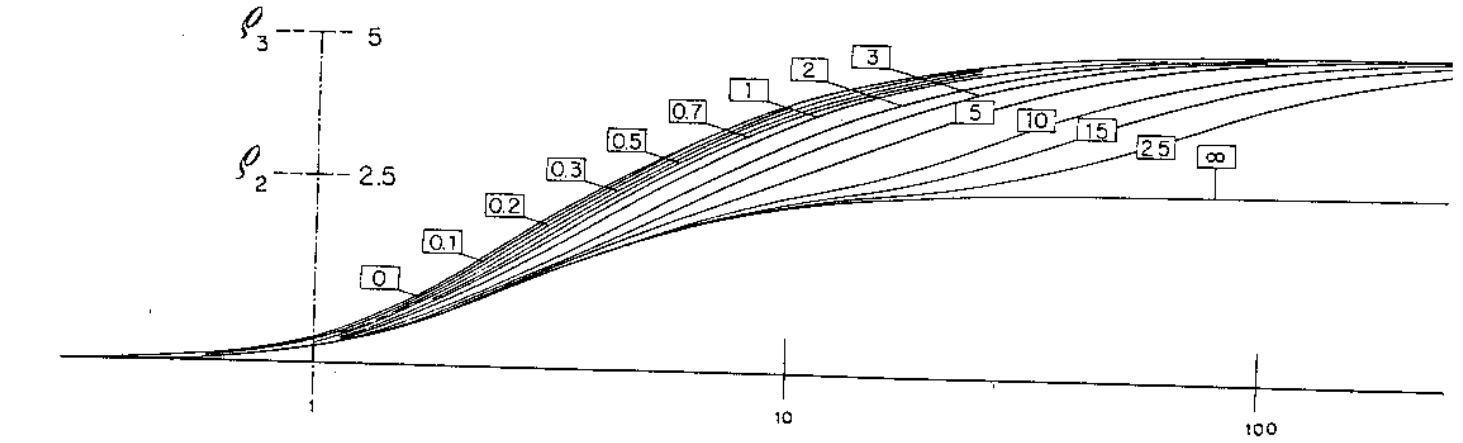

A-5

1-2.5-10

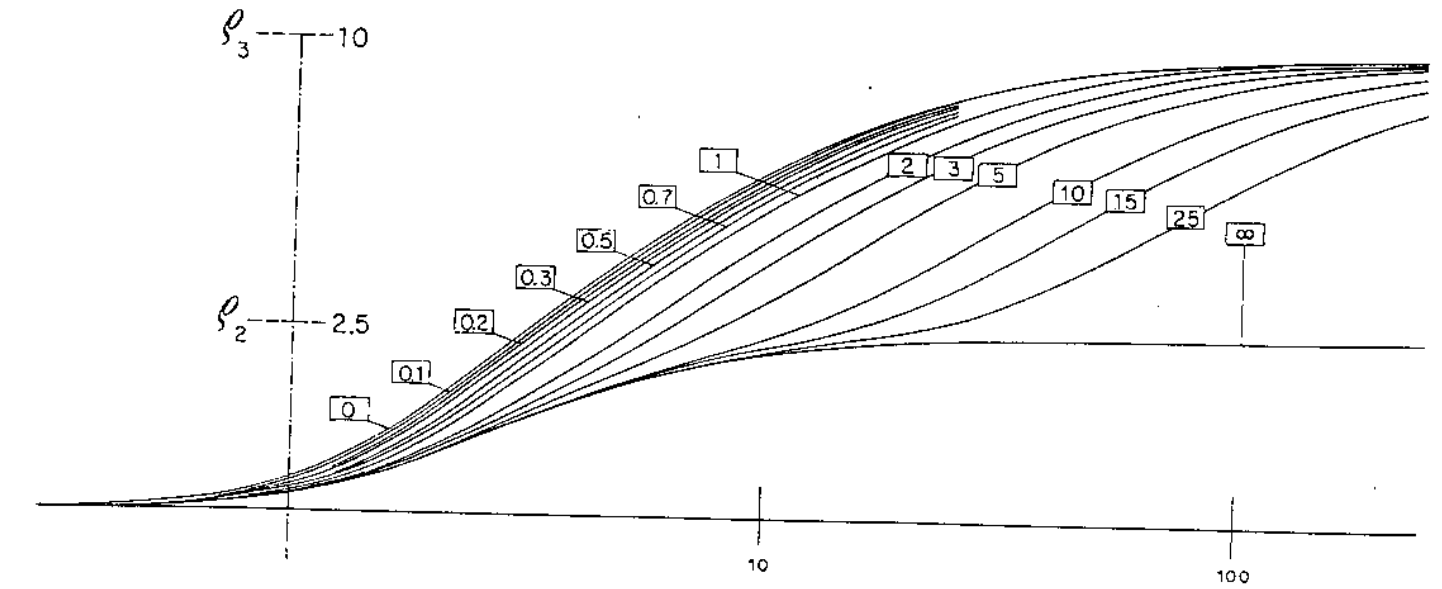

$$E_1 = 1; \rho_1 = 1; E_2 = \square$$

A - 6

1 - 2.5 - ∞

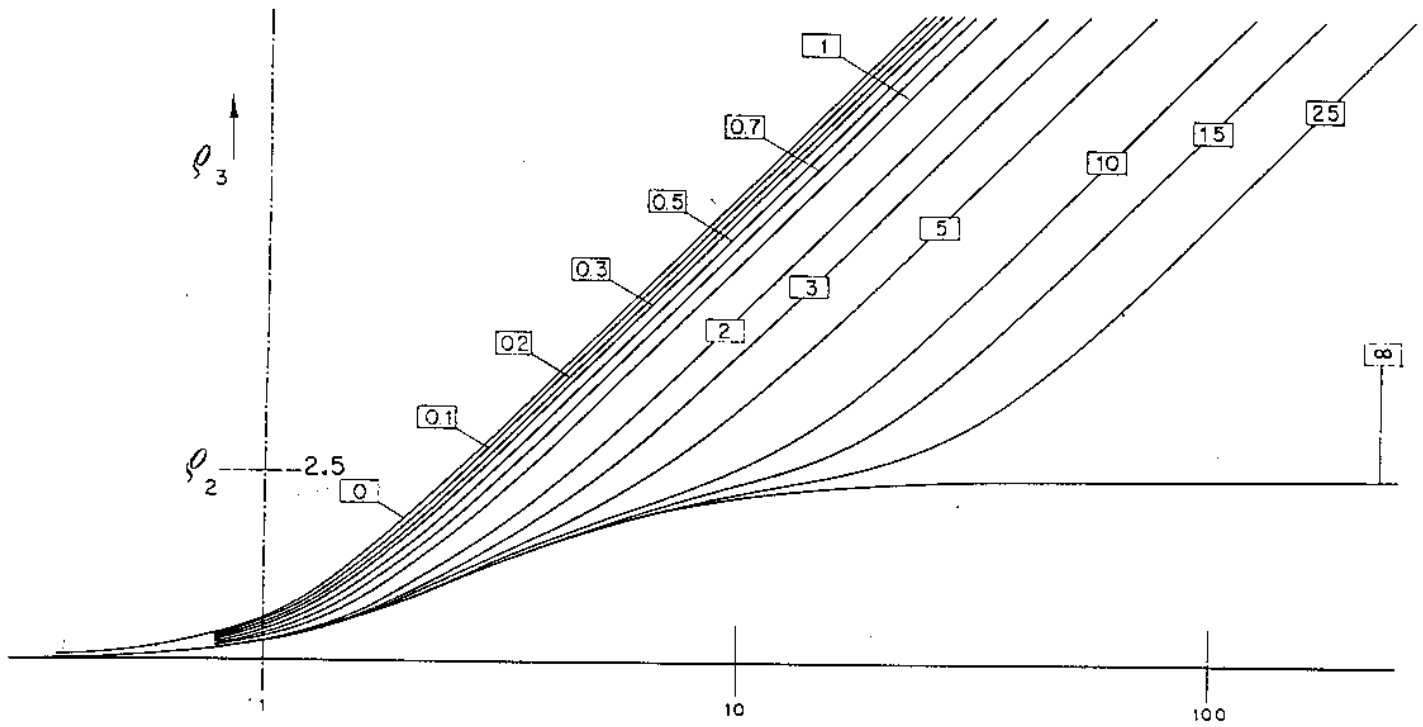

ρ_a \rightarrow AB/2

1 - 5 - 10

A - 7

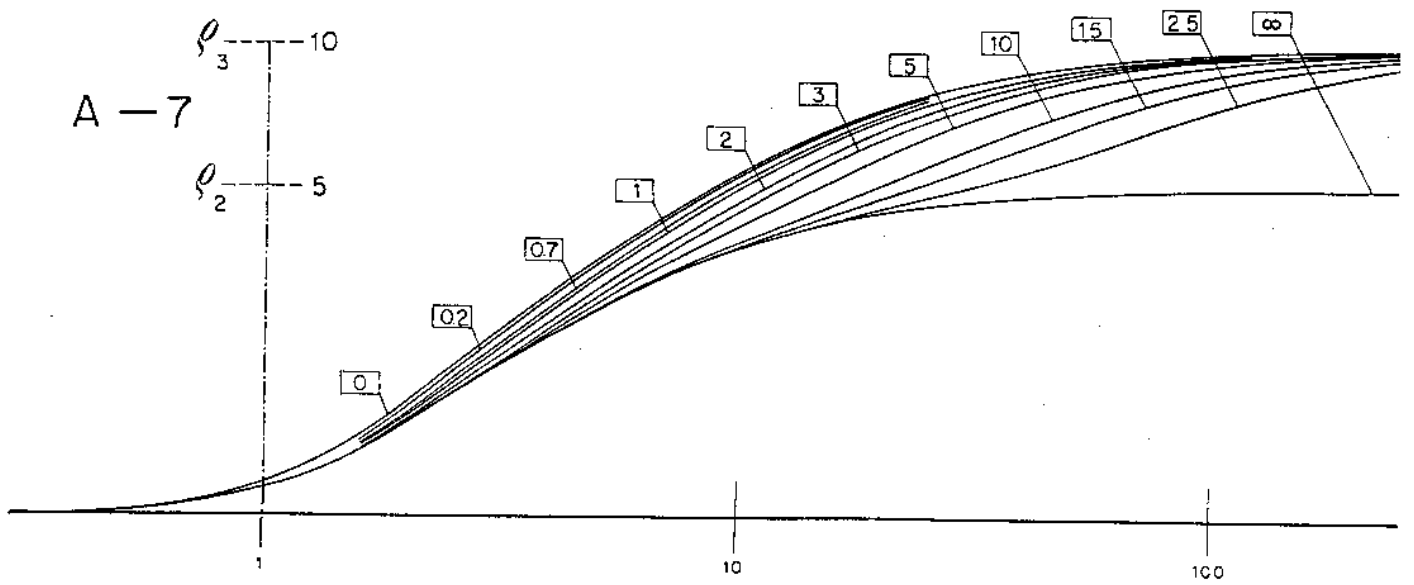

ORELLANA — MOONEY
 MASTER CURVES FOR V.E.S.
 CURVAS PATRON PARA SEV.

$E_1 = 1; \rho_1 = 1; E_2 = \square$

A-8

1-5-20

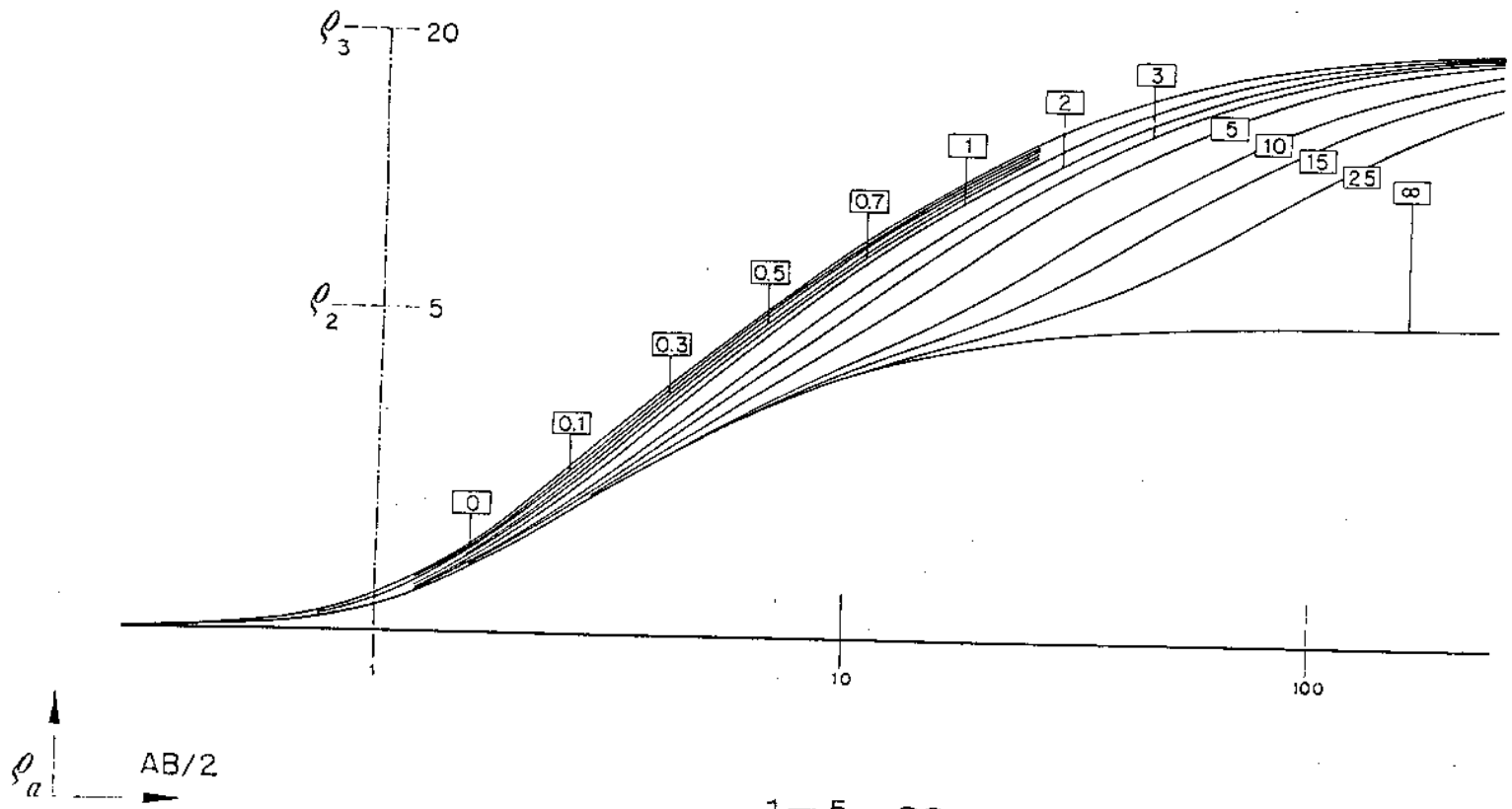

1-5-∞

A-9

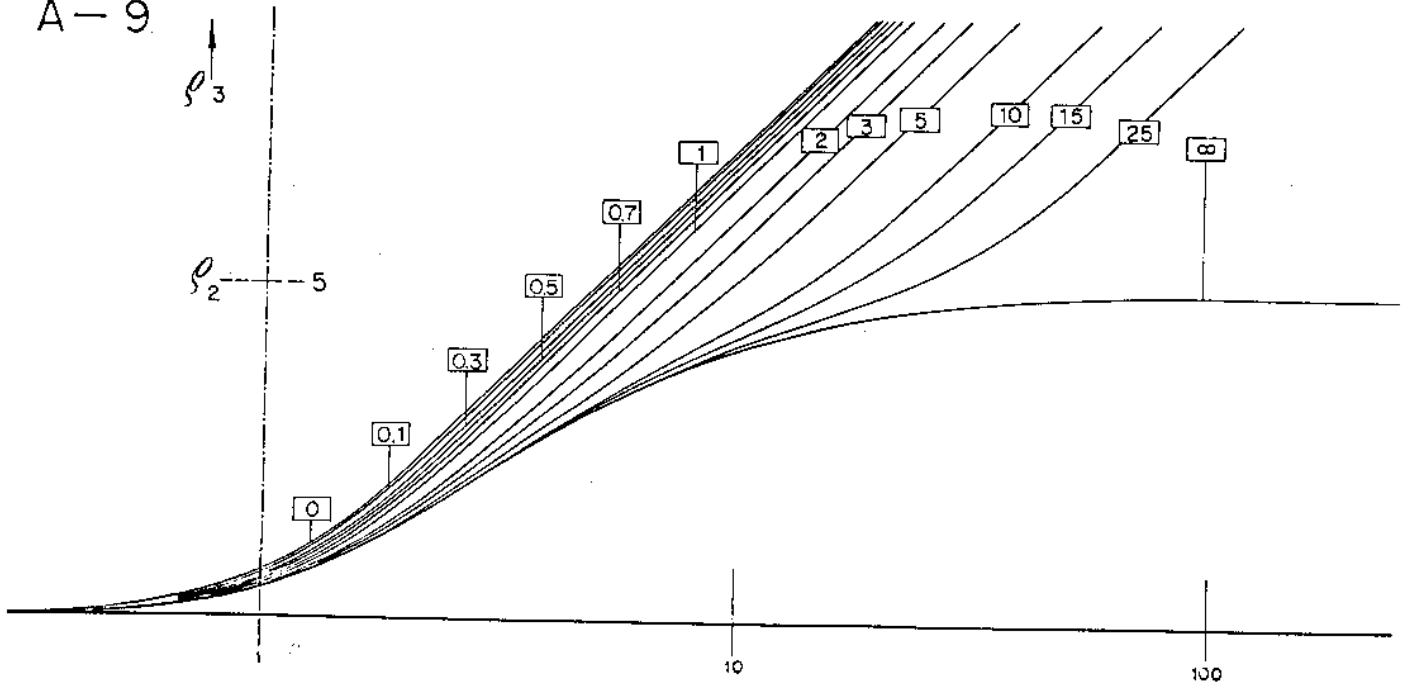

ORELLANA—MOONEY
 MASTER CURVES FOR V.E.S.
 CURVAS PATRON PARA SEV.

$$E_1 = 1; \rho_1 = 1; E_2 = \square$$

A-10

1-10-20

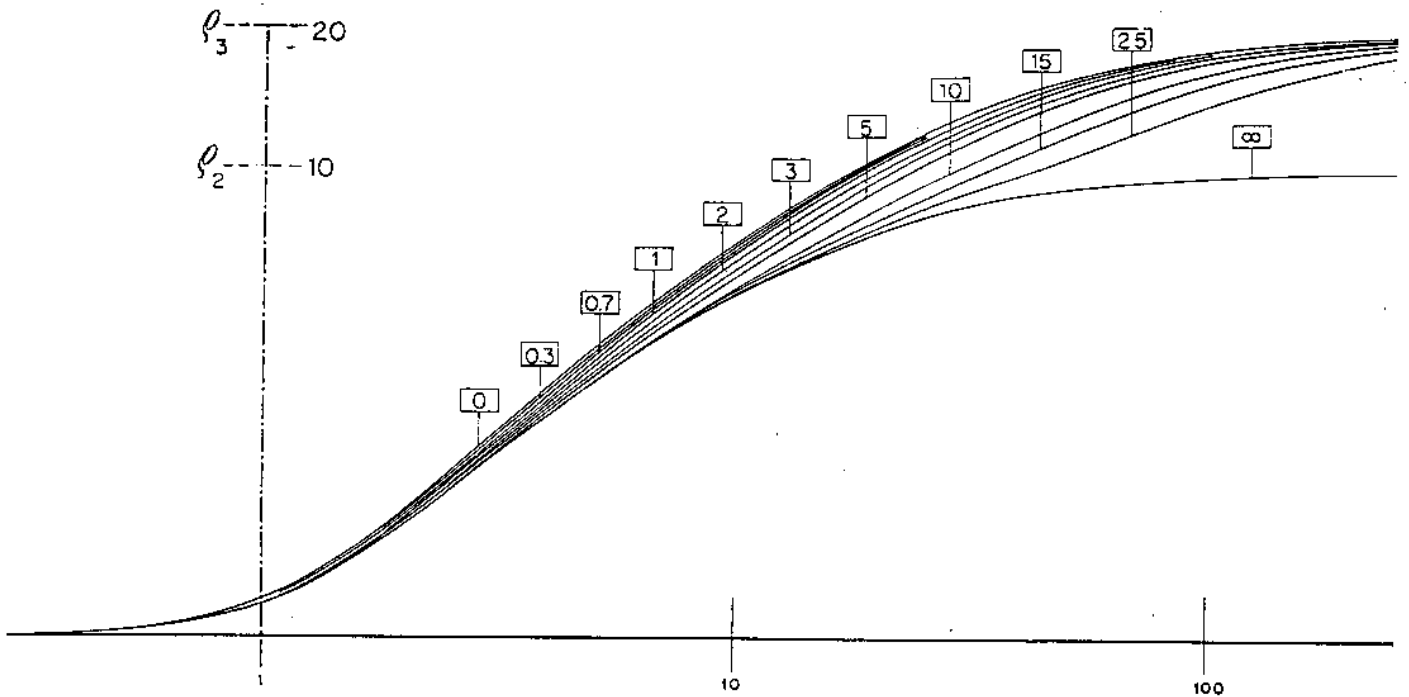

ρ_a \rightarrow $AB/2$

A-11

1-10- ∞

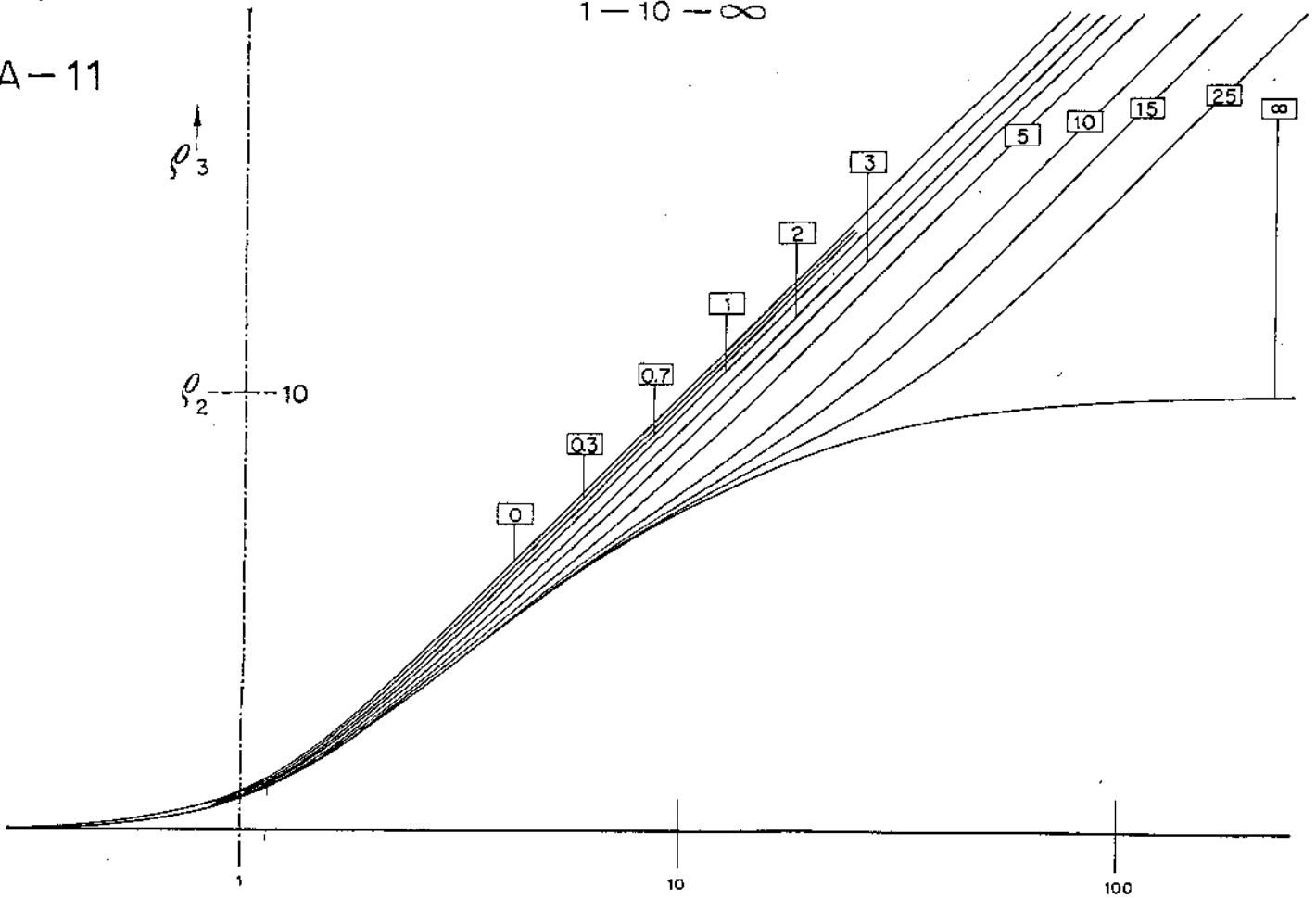

ORELLANA — MOONEY
 MASTER CURVES FOR V.E.S.
 CURVAS PATRON PARA S.E.V.

$E_1 = 1; \rho_1 = 1; E_2 = \square$

1-20-∞

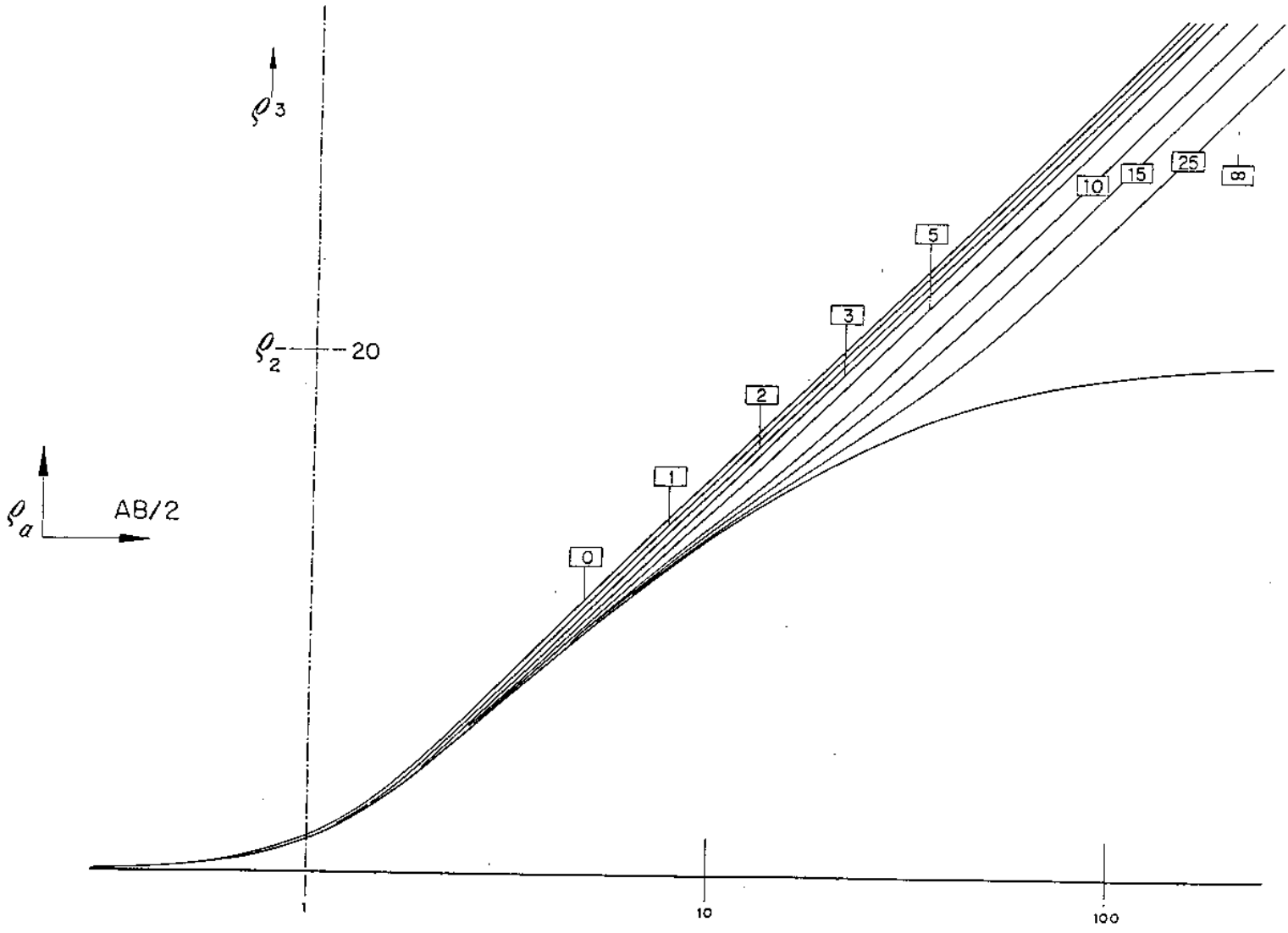

ORELLANA - MOONEY
 MASTER CURVES FOR VES.
 CURVAS PATRON PARA SEV.

$$E_1 = 1; \rho_1 = 1; E_2 = \square$$

A-13

1-40-∞

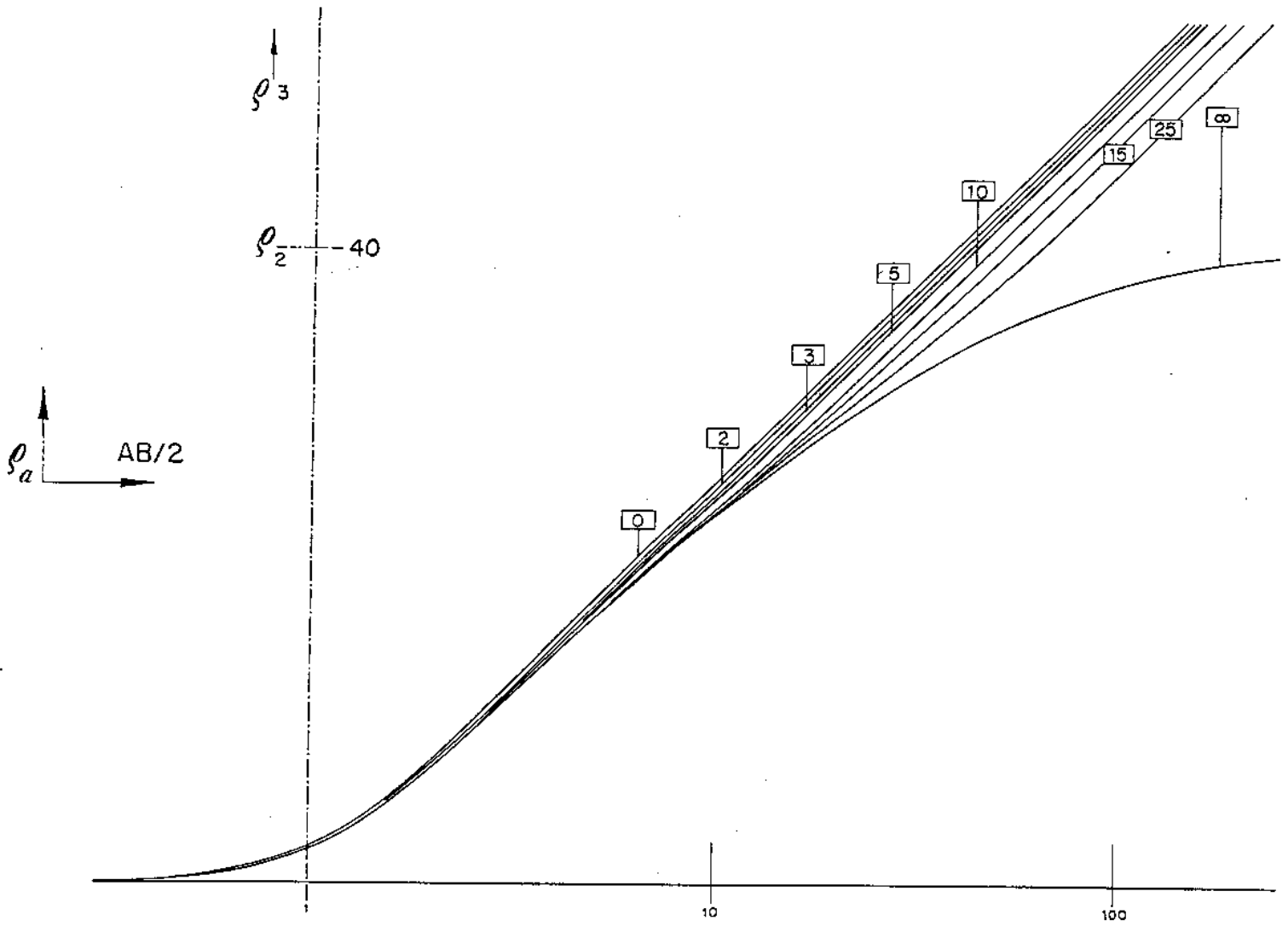

ORELLANA — MOONEY
MASTER CURVES FOR V.E.S.
CURVAS PATRON PARA S.E.V.

$$E_1 = 1; \rho_1 = 1; E_2 = \square$$